

AR740 ROUTER

QUICK START GUIDE

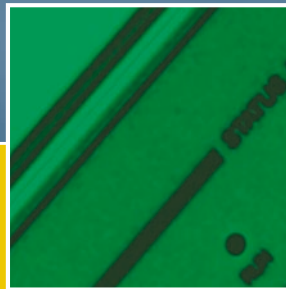
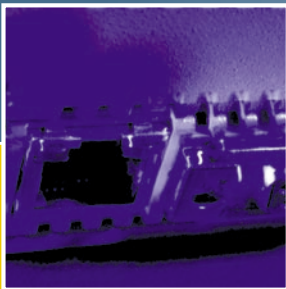
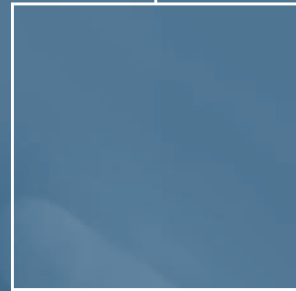

AR740 Router Quick Start Guide.
Document Number C613-04016-00 REV B.

Copyright © 2000-2001 Allied Telesyn International, Corp.
960 Stewart Drive, Suite B, Sunnyvale CA 94085-3912, USA.

All rights reserved. No part of this publication may be reproduced without prior written permission from Allied Telesyn.

Allied Telesyn International, Corp. reserves the right to make changes in specifications and other information contained in this document without prior written notice. The information provided herein is subject to change without notice. In no event shall Allied Telesyn be liable for any incidental, special, indirect, or consequential damages whatsoever; including but not limited to lost profits, arising out of or related to this manual or the information contained herein, even if Allied Telesyn has been advised of, known, or should have known, the possibility of such damages.

All trademarks are the property of their respective owners.

Contents

Introducing the AR740 Router	4	Configuring ISDN	13
Connectivity Options	4	Configuring Basic Rate ISDN	13
What can the AR740 Do For You?	4	Configuring Primary Rate ISDN	14
The AR740 Feature Set	5	Configuring ISDN Dial on Demand	16
About this Guide	5	Configuring ISDN Bandwidth on Demand	16
Where to Find Safety and Statutory Information	5	Configuring an IP Network	17
Getting Connected	6	Before You Start	17
Using Windows Terminal or Windows Hyperterminal as the Console	6	Configuring IP	18
Connecting to an Ethernet LAN	8	Troubleshooting IP Configurations	19
Connecting to a Leased Line Circuit	8	Configuring a Novell IPX Network	20
Ordering ISDN in the USA and Canada	9	Before You Start	20
Connecting to a Basic Rate S/T ISDN Service	9	Configuring IPX	21
Connecting to a Basic Rate U ISDN Service	9	Troubleshooting IPX Configurations	22
Connecting to a Primary Rate ISDN Service	10	Configuring IPX Dial on Demand	23
Connecting a Terminal or Modem	10		
Documentation and Tools CD-ROM	12		
Using the CD-ROM	12		
Using AT-TFTP Server	12		

Introducing the AR740 Router

Congratulations on purchasing an AR740 Modular Branch Office Router—the optimal solution for larger branch and corporate sites with demanding network requirements.

This guide will introduce you to the AR740 router and guide you through the most common uses and applications. Getting started will not take long—many applications can be set up in just a few minutes. If you have any questions about the AR740 router, contact your local distributor or reseller.

CONNECTIVITY OPTIONS

The AR740 supports a wide range of network interfaces so you can choose the network service that is right for you. The base unit has two 10/100 Fast Ethernet port and two RJ45 asynchronous ports. Additional interfaces can be added by installing any of the following PICs (*Port Interface Cards*) in the two PIC bays, or by installing an NSM (Network Service Module) in the NSM bay. The AR040 4-PIC NSM allows an additional four PICs to be installed.

Option	Description
AR020 PIC	1 Primary Rate ISDN E1/T1 interface
AR021(S) PIC	1 Basic Rate ISDN S/T interface
AR021(U) PIC	1 Basic Rate ISDN U interface
AR022 PIC	1 Ethernet AUI/10BASET interface
AR023 PIC	1 Synchronous (2Mbps) universal interface
AR024 PIC	4 Asynchronous (115Kbps) interfaces
AR025 PIC	1 Primary Rate ISDN/G.703 E1 interface
AR040 NSM	4 PIC bays

WHAT CAN THE AR740 DO FOR YOU?

Connect You to the Internet

The AR740 router provides you with high speed, unrestricted access to the Internet. Advanced compression techniques together with ISDN channel bundling mean that graphic downloads simply speed along. The intelligent bandwidth management facility automatically opens more ISDN channels when extra capacity is required, and closes them when traffic levels reduce. The AR740 supports advanced features that make it easy for your Internet Service Provider to dynamically assign your Internet address every time you surf the net.

Connect Branch and Corporate Offices

High performance RISC-based technology ensures the high data throughput demanded by data intensive and multimedia applications. Powerful firewall features protect against unauthorised access, and break-in attempts can be logged for later analysis. If your office LAN uses private IP addresses not registered on the Internet, the AR740 can translate these private addresses to a single registered IP address for communication across the Internet, saving you the time and expense of assigning registered IP addresses to each device on your LAN.

Connect You to Other Trading Partners

The AR740 allows companies to communicate with other trading partners using ISDN, leased line, Frame Relay or X.25 services. Information such as reports, quotes and orders can be transferred between the two offices. The AR740 does not place any limits on the number of network users, so it will continue to support you as your business grows.

Connect Teleworkers and Dial-in Users

The AR740 supports up to 26 dial-in connections via external modems using the AR040 4-PIC NSM and six AR024 PICs. Teleworkers and mobile users can dial into an AR740 router at their local office and access information, read email, download files and connect to the Internet. Combine dial-in services with AT-VPNnet to provide teleworkers and mobile users with secure access to the corporate network. External modems can also be used to provide network connections for extra bandwidth at peak times or to backup ISDN, Frame Relay or leased lines.

Protect Your Network from Unauthorised Access

When you connect to the Internet you have unrestricted access to the World-Wide Web. Likewise, it has access to you! To ensure that only authorised users can access your local network, the AR740 has an extensive range of security measures, including:

- A fully featured stateful inspection firewall which dynamically filters traffic flows based on manager-defined rules. All firewall events are logged to the router's Logging Facility, and significant events generate notifications via SNMP traps, email or triggers. The firewall automatically detects and combats a range of denial of service attacks including SYN

and FIN flooding, Ping of death, Smurf attacks and port scans.

- IPsec-compliant security services.
- Calling Line Identification (CLI), which uses the ISDN address of the incoming call to verify that the caller is calling from an authentic location.
- ISDN callback, which verifies the caller using CLI, disconnects the incoming call, then calls the destination back to establish the link. This allows a remote site to reverse the call charges to a central office, for central billing of ISDN calls.
- PAP and CHAP to authenticate remote access using passwords and user names.
- TACACS and RADIUS for authenticating users. The AR740 can query TACACS or RADIUS servers running on a network host to authenticate users. A centralised database simplifies management of a large user population.

Protect Your Data with Powerful DES Encryption

If you are transmitting sensitive information, such as cost estimates, product plans, and investment opportunities across the Internet you want to secure this data so that it is indecipherable to all but the intended recipients. AT-VPNNet provides powerful DES or 3DES encryption. Your data is scrambled before it is transmitted across the Internet, making the data meaningless if intercepted. Only the data portion of the IP packet is encrypted; the address information required for routing the packet to its destination is unchanged. AT-VPNNet uses a separate daughter card that fits inside the AR740 to offload the processor-intensive task of data encryption, so routing performance is not affected.

Note: The export of strong DES-based cryptography such as AT-VPNNet is subject to export controls in most countries. Contact your distributor or reseller for details.

THE AR740 FEATURE SET

The following are just some of the features provided by the AR740:

- Wide-area networking via Frame Relay, Point-to-Point Protocol, and X.25.
- Basic Rate and Primary Rate access to Integrated Services Digital Network (ISDN) services, with dial on demand, bandwidth on demand and channel aggregation facilities.
- Multiprotocol routing, including TCP/IP, Novell® IPX, DECnet™, AppleTalk® and GRE (*Generic Routing Encapsulation*) protocols. Supported routing protocols include RIP and RIP v2, EGP, OSPF, and Novell® RIP and SAP.

- Terminal server.
- Bridging.
- Backup server for leased line, PSTN and ISDN.
- LPD and Streams print server for network-wide printing.
- Advanced packet filtering for IP, Novell® IPX and DECnet™.
- Frame Relay over synchronous and ISDN links, with logical interfaces, congestion control and a slowstart mechanism.
- Bandwidth management, multilink PPP channel aggregation, network on demand and bandwidth on demand.
- Hardware-based data encryption and compression.
- Traffic shaping and Quality of Service (QoS) with the Resource Reservation Protocol (RSVP) and Bandwidth Allocation Control Protocol (BACP).
- X.25 communications server.
- TDM (Time Division Multiplexing).
- Automated network monitoring and control with a sophisticated, configurable event logging facility.
- Triggers for automatic and timed execution of commands, and scripting for automated configuration and centralised management of configurations.
- Support for the Simple Network Management Protocol (SNMP) allows the router to be managed by a separate network management station.

ABOUT THIS GUIDE

Before you use your AR740 router in a live network, please read this guide. This guide contains the following:

- Instructions for and connecting the router to different physical networks and network services.
- Instructions for installing the AR Series Router Documentation and Tools CD-ROM and using the online documentation.
- Simple 'get-you-running' instructions for the most popular IP and Novell® IPX applications, using the router's command line interface.

WHERE TO FIND SAFETY AND STATUTORY INFORMATION

Safety and statutory information can be found in the AR700 Series Router Safety and Statutory Information booklet. This booklet can be found on the CD-ROM bundled with your router, or at www.alliedtelesyn.co.nz.

Getting Connected

This section describes how to connect the AR740 router to different physical devices and networks. Before you start, you should be aware that the AR740 router refers to its physical interfaces as *ports* and these are numbered, starting at 0. Ports on the base unit are numbered first, followed by ports on PICs (*Port Interface Cards*) in Bay 0 and Bay 1, then by ports on an NSM installed in the NSM bay. For example, eth0 is the first Ethernet port and syn1 is the second synchronous port.

USING WINDOWS TERMINAL OR WINDOWS HYPERTERMINAL AS THE CONSOLE

You can use a PC running terminal emulation software as the manager console, instead of a terminal. There are many terminal emulation applications available for the PC, but the most readily available are the Terminal and HyperTerminal applications included in Microsoft® Windows™ 3.1 and Windows 95, respectively. In a normal Windows™ installation Terminal is located in the Accessories group. In Windows 95 HyperTerminal is located in the Start > Programs > Accessories menu.

The key to using terminal emulation software successfully with the AR740 router is to configure the communications parameters in the terminal emulation software to match the default settings of the console port on the router. The following procedures describe how to configure Windows™ Terminal and HyperTerminal for the default console port settings on the AR740 router, but the same principles apply to other terminal emulation programs.

To configure Windows™ Terminal, follow these steps:

1 In Windows 3.1, double-click the Terminal icon in the Accessories group in Program manager.

2 Select “Communications” from the Settings menu. The Communications dialog box is displayed.

Set “Baud Rate” to 9600, “Data Bits” to 8, “Stop Bits” to 1, “Parity” to None, “Flow Control” to Hardware and “Connector” to the COM port on the PC used to connect to the router. Uncheck the “Parity Check” and “Carrier Detect” checkboxes. Click “OK” to accept the new settings and close the dialog box.

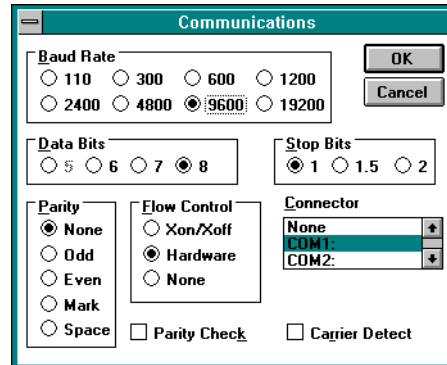

3 Select “Terminal Emulation” from the Settings menu. In the Terminal Emulation dialog box check “DEC VT-100 (ANSI)” and click “OK”.

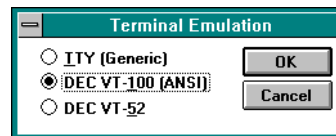

4 Select “Terminal Preferences” from the Settings menu. In the Terminal Preferences dialog box uncheck “Local Echo”, “CR -> CR/LF”, and “Use Function, Arrow, and Ctrl Keys for Windows”. Set other parameters as required, then click “OK”.

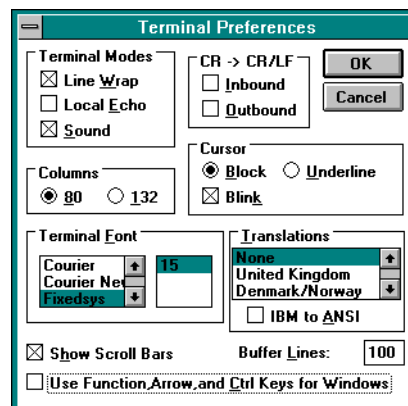

5 To save the configuration, select “Save As” from the File menu, then type a file name and press [Enter]. To reuse the configuration in a future session, select “Open” from the File menu, select the file name from the list and click “OK”.

6 You can customise Windows™ Terminal further by assigning commonly used router commands to function keys. Select “Function Keys” from the Settings menu, or select “Contents” from the Help menu and click on the topic “Assign Tasks to Function Keys”. To save the function key assignments, follow step 5 above.

To configure Windows 95 HyperTerminal, follow these steps:

1 In Windows 95, from the Start Menu, select Programs > Accessories > HyperTerminal to display the HyperTerminal group. Double-click the Hypertrm.exe icon.

2 In the Connection Description dialog box, enter a name for the connection (e.g. AR740) and select an icon from the scrolling list. Click “OK”.

3 In the Phone Number dialog box, from the “Connect using:” dropdown list select the “Direct to Com n” to match the COM port on the PC used to connect to the router. Click “OK”.



4 In the COMn Properties dialog box set “Bits per second” to 9600, “Data bits” to 8, “Parity” to None, “Stop bits” to 1 and “Flow control” to Hardware. Click “OK”.

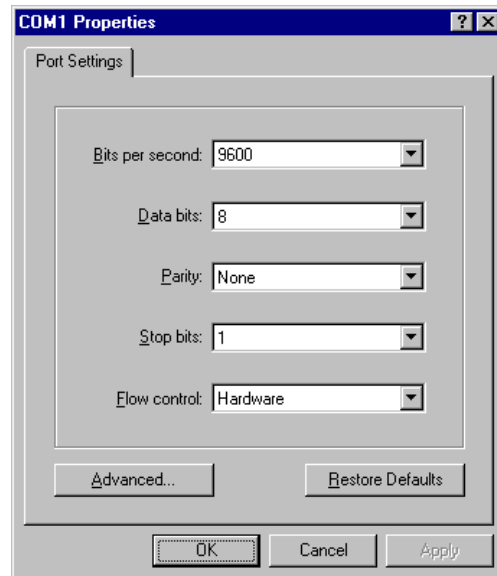

5 Select “Properties” from the File menu. In the Connection Properties dialog box, click the Settings tab and set “Function, arrow, and ctrl keys act as” to “Terminal keys” and “Emulation” to VT100.

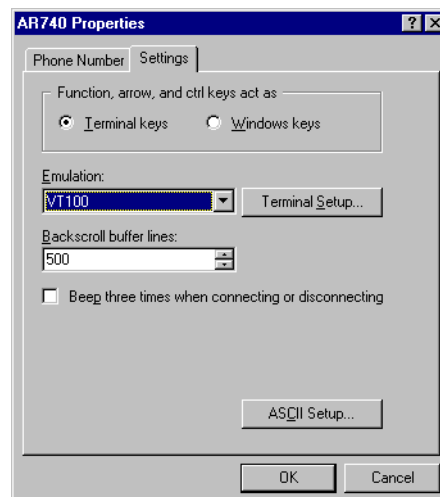

6 Click “ASCII Setup” to display the ASCII Setup dialog box. Uncheck the “Echo typed characters locally” and “Append line feeds to incoming line ends” checkboxes. Set other parameters as required, then click “OK” twice to dismiss all dialog boxes.

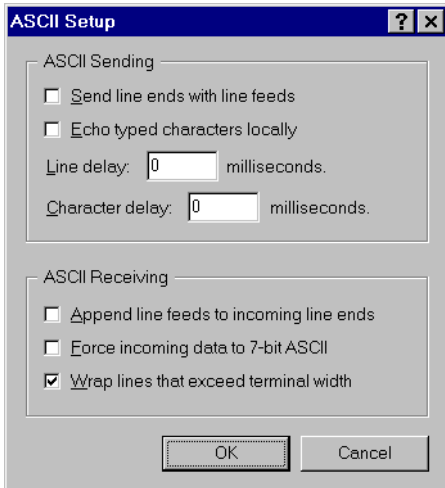

7 Select “Save” from the File menu to save the current session. This creates a connection icon with the name you assigned in the HyperTerminal group. To use the configuration, double-click the connection icon in the HyperTerminal group. When the HyperTerminal window appears, press [Enter] a couple of times. The router’s login prompt will appear.

CONNECTING TO AN ETHERNET LAN

To connect the AR740 router to an Ethernet LAN, follow these steps:

1 The Ethernet port on the AT-AR022 Ethernet PIC is a 10 Mbps port with dual AUI and TP interfaces. Connect the Ethernet LAN to only one of the interfaces. The PIC will automatically sense which interface is in use. The Ethernet ports on the AR740 base unit are 10/100 Fast Ethernet ports with RJ45 TP interfaces.

2 To connect the AR740 to the Ethernet LAN via a TP interface, use the supplied CAT 5 Ethernet cable or an approved equivalent. To connect the AR740 to the Ethernet LAN via an AUI interface, use a transceiver.

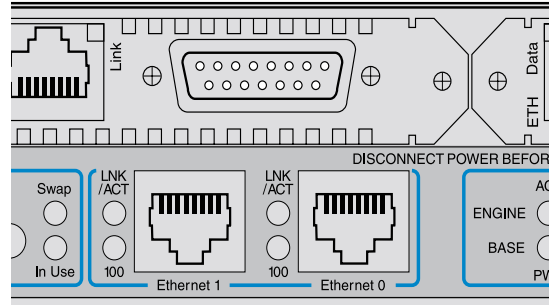

Connect the LAN to an Ethernet port on the rear panel of the AR740 using the supplied CAT 5 cable.

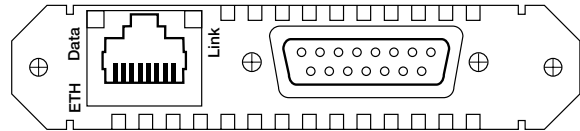

Connect the LAN to the TP port on the rear panel of the AT-AR022 Ethernet PIC using the supplied CAT 5 cable. Use a transceiver to connect the AUI port to the LAN.

3 Check the operation by observing the state of the LEDs on the rear panel of the router or PIC. The Tx and Rx LEDs will be lit as data is transmitted and received via the interface. The Lnk LED (if present) will be lit when the Ethernet port is connected to a hub, PC or a LAN with at least one other device attached.

CONNECTING TO A LEASED LINE CIRCUIT

To connect the AR740 router with an AT-AR023 SYN PIC installed to a synchronous leased line circuit, follow these steps:

1 Using the appropriate approved transition cable (RS-232, X.21 or V.35), connect the synchronous port on the rear panel of the AT-AR023 SYN PIC to the telecommunication service provider’s NTU.

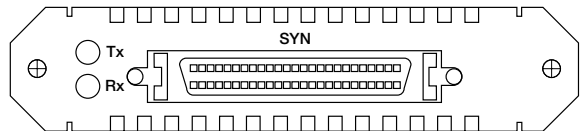

Connect the NTU to the synchronous port on the rear panel of the AT-AR023 SYN PIC using the appropriate approved transition cable.

- 2 Check the configuration of the port, by typing the command:

```
SHOW SYN=n
```

where *n* is the synchronous port number. Verify that the information displayed is correct. In particular, "State" should be set to "enabled" and "Interface type" should match the transition cable used.

- 3 Configure a data link layer module, such as PPP (*Point-to-Point Protocol*), Frame Relay or X.25 LAPB, to use the synchronous interface. To create a PPP interface 0 to use synchronous port 0, type the command:

```
CREATE PPP=0 OVER=SYNO
```

- 4 Check the configuration by typing the commands:

```
SHOW SYN=0
SHOW PPP=0
```

The output of the SHOW SYN command should show "Active" set to "yes" and "Module" set to "ppp". The output of the SHOW PPP command should show interface ppp0 over syn0 with "LCP" as the control protocol. The Tx and Rx LEDs will be lit as data is sent and received on the interface.

ORDERING ISDN IN THE USA AND CANADA

In the United States and Canada, Basic Rate ISDN is provided using National ISDN-I, 5ESS or DMS-100 formats, all of which are supported by the AR740 router. If National ISDN-I is available, you can select from a list of "Capability Packages", each providing different features. Contact your ISDN service provider for more information. The AR740 router will accept either one or two Service Profile Identifiers (SPIDs).

CONNECTING TO A BASIC RATE S/T ISDN SERVICE

Warning: The factory default hardware settings described here are correct for European Union (EU) countries. For other countries, contact your distributor or reseller for details of local requirements.

To connect an AR740 router with an AT-AR021(S) BRI-S/T PIC installed to a Basic Rate S/T ISDN service, follow these steps:

- 1 Check that the AT-AR021(S) BRI-S/T PIC has the correct termination for the local conditions. The AT-AR021(S) PIC can only operate in TE mode and is shipped with the standard 100Ω termination jumpers removed. This is appropriate for most situations, where the local building wiring provides the ISDN termination. Your distributor or reseller can advise you whether or not termination jumpers are required.

- 2 Connect the supplied CAT 5 cable, or an approved ISDN cable, from the BRI interface on the rear panel of the AT-AR021(S) PIC to the ISDN service provider's termination point (NT1).

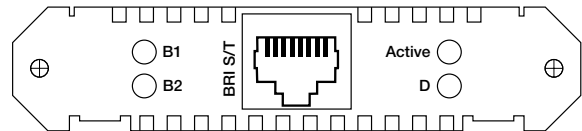

Connect the supplied CAT 5 cable or an approved ISDN cable from the BRI port on the rear panel of the AT-AR021(S) BRI-S/T PIC to the NT1.

Note: If you wish to make your own ISDN cable, see the AR Router Hardware Reference for a detailed description of how to wire an ISDN interface cable.

- 3 Check the operation by observing the state of the LEDs on the rear panel of the AT-AR021(S) PIC. In some territories (e.g. New Zealand and the European Union) the Active LED will be lit if the link to the NT1 is operational. In other territories (e.g. Australia) the Active LED will only be lit when the router attempts a call. The D LED will flicker as control traffic is exchanged with the ISDN switch. The B1 and B2 LEDs will flicker as data is sent and received on the B1 and B2 channels.

To test the AT-AR021 PIC you will need to configure a routing protocol such as IP or IPX to use ISDN. See *Configuring ISDN*, *Configuring an IP Network* and *Configuring a Novell IPX Network* later in this guide for more information about configuring ISDN calls and routing protocols.

CONNECTING TO A BASIC RATE U ISDN SERVICE

To connect an AR740 router with an AT-AR021(U) BRI-U PIC installed to a Basic Rate U ISDN service, follow these steps:

- 1 Connect the supplied CAT 5 cable or an approved ISDN cable from the BRI interface on the rear panel of the AT-AR021(U) PIC to the ISDN service provider's termination point (ISDN line wall jack).

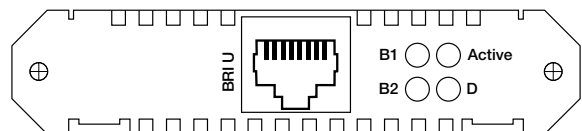

Connect the supplied CAT 5 cable, or an approved ISDN cable, from the BRI port on the rear panel of the AT-AR021(U) BRI-U PIC to the ISDN line wall jack.

Note: If you wish to make your own ISDN cable, see the AR Router Hardware Reference for a detailed description of how to wire an ISDN interface cable.

2 Check the operation by observing the state of the LEDs on the rear panel of the AT-AR021(U) PIC. The *Active* LED will be lit when the U interface is activated and operational at the physical layer. The *D* LED will flicker as control traffic is exchanged with the ISDN switch. The *B1* and *B2* LEDs will flicker as data is sent and received on the B1 and B2 channels.

To test the AT-AR021(U) PIC you will need to configure a routing protocol such as IP or IPX to use ISDN. See *Configuring ISDN, Configuring an IP Network* and *Configuring a Novell IPX Network* later in this guide for more information about configuring ISDN calls and routing protocols.

CONNECTING TO A PRIMARY RATE ISDN SERVICE

To connect an AR740 router with an AT-AR020 PRI E1/T1 PIC installed to a Primary Rate ISDN service, follow these steps:

1 Check that the AT-AR020 PRI E1/T1 PIC has the correct mode and termination for local conditions. The AT-AR020 PRI E1/T1 PIC is shipped pre-configured for normal LT operation in T1 mode, with the standard termination jumpers removed. This is appropriate for most situations. If the PIC is to be operated in a non-standard mode, contact your distributor or reseller. The commands:

```
SHOW PRI STATE
SHOW PRI CONFIGURATION
```

display the state of the PRI interface and the modules configured to use the PRI interface. Check the output of the SHOW PRI STATE command that "ISDN Interface type" is set to "TE". If not, contact your distributor or reseller for assistance, or see the *AR Series Router Reference Manual* for more information.

2 Connect an approved ISDN 120Ω cable from the ISDN service provider's termination point to the PRI interface on the rear panel of the AT-AR020 PRI E1/T1 PIC. If the router is being connected to a 75Ω network, an external balun is required. Contact your distributor, reseller or ISDN service provider for assistance.

Note: If you wish to make your own ISDN cables, see the AR Router Hardware Reference for a detailed description of how to wire an ISDN interface cable.

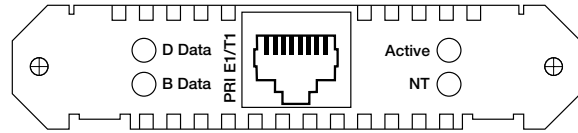

Connect the Primary Rate ISDN port on the rear panel of the AT-AR020 PRI E1/T1 PIC to the ISDN service provider's termination point using an approved ISDN 120Ω cable or external balun.

3 Check the operation by observing the state of the LEDs on the front panel of the AT-AR020 PIC. The "Active" LED should be lit indicating the link to the NT is operational. The "D Data" LED will flicker as control traffic is exchanged with the ISDN switch. The "B Data" LED will flicker as data is transmitted and received on any B channel. The "NT" LED indicates that the PRI interface is in NT mode, and should not be lit during normal operation. See *Configuring ISDN, Configuring an IP Network* and *Configuring a Novell IPX Network* later in this guide for more information about configuring ISDN calls and routing protocols.

CONNECTING A TERMINAL OR MODEM

To connect a terminal or modem to an asynchronous port on the AR740 router, follow these steps:

1 Use the supplied console cable or an approved terminal cable to connect a terminal to an asynchronous port on the rear panel of the router or the rear panel of an AT-AR024 ASYN4 PIC. Use an approved modem cable to connect a modem to an asynchronous port on the rear panel of the router or the rear panel of an AT-AR024 ASYN4 PIC.

Note: If you wish to make your own cable, see the AR Router Hardware Reference for a detailed description of how to wire a terminal or modem cable.

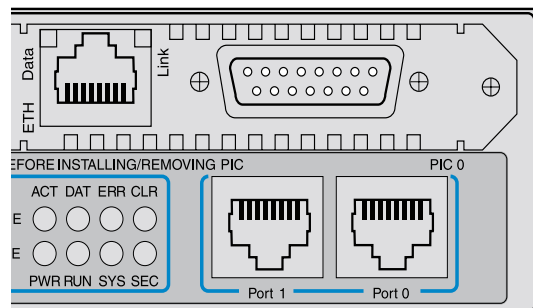

Connect the terminal or modem to an asynchronous port (Port 0 or Port 1) on the rear panel of the AR740 router using an approved cable.

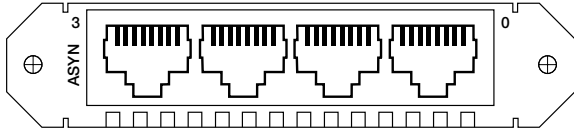

Connect the terminal or modem to an asynchronous port on the rear panel of the ATAR024 ASYN4 PIC using an approved cable.

2 Check that the terminal or modem's communication settings match the settings of the asynchronous port. By default, asynchronous ports on the AR740 router are set to 9600 baud, 8 data bits, 1 stop bit, no parity and hardware flow control. Refer to the user manual supplied with the terminal or modem for details of how to change the communications settings for the terminal or modem.

If the terminal or modem is to be used with communications settings other than the default settings, the asynchronous port must be configured to match the terminal or modem settings using the SET PORT command. If a modem is being connected, the CDCONTROL parameter must be set to "CONNECT" and the FLOW parameter must be set to "HARDWARE". See the router's online help or the *AR Series Router Software Reference* for more information.

3 If a modem is being connected, the router must be configured to make and/or accept calls via the modem. See the router's online help or the *AR Series Router Software Reference* for more information.

Documentation and Tools CD-ROM

The AR Series Router Documentation and Tools CD-ROM is bundled with every AR router and includes:

- The *AR Series Router Documentation Set* in Adobe Acrobat PDF format—the complete reference to installing, configuring and managing the AR series of multiprotocol routers, including detailed descriptions of all commands.
- Application Notes—a collection of technical and background papers on the application of AR router technologies.
- Configuration Examples—a collection of ready-to-use examples of typical network configurations, complete with scripts to download to an AR router using AT-TFTP.
- AT-TFTP Server for Windows, for downloading software releases, scripts and other files to or from an AR router.
- Adobe Acrobat Reader for Windows for viewing and printing the online documentation in PDF format. Get instant access to information with full-text searching of PDF documents by keyword or phrase.
- Microsoft Internet Explorer and Netscape Communicator.
- Demonstration versions of networking utilities, such as AR-Remote File Manager (AR-RFM) from Allied Telesyn and F-Secure's Secure Shell client for Windows.

USING THE CD-ROM

To use the CD-ROM, follow these steps:

- 1 Insert the CD-ROM in the CD-ROM drive.
- 2 If the CD Browser menu does not appear automatically after a few seconds, select "Run" from the Start Menu and type **d:\start.exe** (where **d:** is the CD-ROM drive letter). Click OK.
- 3 To view a document, click on the document title. To navigate around PDF documents, do one of the following:
 - Use the toolbar buttons, keyboard shortcuts, and commands from the Document menu to page through the document.
 - Click on a bookmark, thumbnail or hypertext link to jump to a specific section or topic.
 - Use the Search command to search for keywords or phrases.

For more information about using the Adobe Acrobat Reader, select "Acrobat Reader Help" from the Help menu.

- 4 To install any of the tools on the CD-ROM, click on the "Tools" button in the CD Browser menu.

USING AT-TFTP SERVER

To use AT-TFTP Server, follow these steps:

- 1 If AT-TFTP Server has not yet been installed, install it now from the AR Series Router Documentation and Tools CD-ROM.
- 2 Select AT-TFTP Server from the Start > Programs > Allied Telesyn > AT-TFTP Server menu.
- 3 To set preferences for the AT-TFTP Server, select "Options" from the File menu to display the "Set Preferences" dialog box.

The "Default file transfer directory" field specifies the directory AT-TFTP Server will read from or write to, for file requests that do not include a directory specification.

To prevent unauthorised access to private directories, enter a path name in the "Restrict to directory" field. AT-TFTP Server will use only the specified directory, even if file requests contain references to other directories.

Select "Read only" to prevent files being written to the PC. To use the PC to archive router scripts created using the router's CREATE CONFIG command, select "Read Write".

Make any required changes and click "OK".

- 4 To load a file from AT-TFTP Server to the router, on a terminal connected to the router type the command:

```
LOAD METHOD=TFTP FILE=filename
SERVER=ipadd DEST=FLASH
```

where *filename* is the name of the file to download and *ipadd* is the IP address of the PC running AT-TFTP Server.

- 5 TFTP requests are logged to the AT-TFTP Server main window. To save the log, select "Save As" from the File menu.

Configuring ISDN

This section describes how to configure ISDN on the AR740 router using the command line interface. ISDN on the router requires minimal user configuration, other than selecting a territory, creating call definitions and configuring the Point-to-Point Protocol (PPP) to use the ISDN calls. The lower layers of the ISDN protocol stack (BRI, LAPD and Q.931) are automatically configured when the router starts up.

Warning: *The factory default hardware and software settings described here are correct for European Union (EU) countries. For other countries, contact your distributor or reseller for details of local requirements.*

CONFIGURING BASIC RATE ISDN

To configure Basic Rate ISDN on the AR740 router, follow these steps:

1 Check the BRI hardware configuration. The AR740 router can only operate in TE mode and is shipped with the standard 100Ω termination jumpers removed. This is appropriate for most situations, where the building wiring provides the ISDN termination. Your distributor or reseller can advise you whether or not termination jumpers should be installed.

2 Select the country in which the router is being operated, using the command:

```
SET SYSTEM TERRITORY={AUSTRALIA|CHINA|
EUROPE|JAPAN|KOREA|NEWZEALAND|USA}
```

The territory determines which Q.931 profile is used on the ISDN interface. For example, to select the Q.931 profile for the United States, use the command:

```
SET SYSTEM TERRITORY=USA
```

Warning: *If you are not sure which territory to use, contact your distributor or reseller. Failure to select the correct territory will invalidate the approval of this product with respect to the applicable national standards for the country in which the product is used.*

For installations in the USA, go to step 4. For installations in other countries, go to step 3.

3 In countries other than the USA, the router's ISDN directory numbers and subaddresses may be set with the command:

```
SET Q931=0 NUM1=number NUM2=number
SUB1=subaddress SUB2=subaddress
```

This step is only required if the router is sharing the ISDN S/T bus with other ISDN devices. See the *AR Series Router Software Reference* for more information.

Go to Step 5.

4 In the USA, the ISDN switch type and SPIDs values may also need to be set. Setting the system territory to USA automatically sets the ISDN switch type to National ISDN-I. This should be correct for all new ISDN installations. If the router is to be connected to another switch type, the switch type can be set with the command:

```
SET Q931=0 PROFILE=DMS-100
```

for a Northern Telecom DMS-100 switch running custom software, or:

```
SET Q931=0 PROFILE=5ESS
```

for a Lucent 5ESS switch running custom software.

If the switch type is not National ISDN-I, the SPIDs (supplied by the ISDN service provider) must also be entered with the command:

```
SET Q931=0 SPID1=spid SPID2=spid
```

If the switch type is National ISDN-I the router will, when first turned on, attempt to obtain the SPIDs itself from the switch using the Auto SPID procedures. The success of this procedure can be monitored with the command:

```
SHOW Q931=0 SPID
```

If the Auto SPID procedure succeeds the router will either select the SPID values to use by itself, or tell the user (in the output of the SHOW Q931=0 SPID command) how to select the SPID values.

If the Auto SPID procedures fail, SPIDs can be entered manually with the command:

```
SET Q931=0 SPID1=spid SPID2=spid
```

Directory numbers and subaddresses can be entered with the command:

```
SET Q931=0 NUM1=number NUM2=number
    SUB1=subaddress SUB2=subaddress
```

The directory numbers and subaddresses must be supplied by the ISDN service provider. If the directory number is a full 10 digit number (3 digit area code plus 7 digit number), the router will append the digits "0101" to the number and attempt SPID initialisation with the result. This is known as the Generic SPID procedure. If SPID initialisation has already taken place and SPIDs have been obtained through the Auto SPID procedure, then either these SPIDs are the same as the Generic SPID and the router will successfully reinitialise, or the SPIDs are not the same as the Generic SPID and the router will not initialise. In this case, the router will revert to using the Auto SPID values.

5 Create ISDN call definitions to enable the router to make ISDN calls to other devices on the ISDN network. This is the only step that must be completed to configure ISDN on the router. Before a call can be made from one router to another, call definitions must be created on both routers, using the command:

```
ADD ISDN CALL=name NUMBER=number
    PRECEDENCE={IN|OUT} options...
```

For example, a Remote Office router is to be connected to the Head Office router via ISDN. The ISDN number of the Remote Office router is 1234567. The ISDN number of the Head Office router is 9876543. The *called party subaddress information element* (IE) is used to carry connection information, and PPP interfaces will be created explicitly to use the ISDN calls. Either router can initiate the call, but calls from the Remote Office have precedence. On the Head Office router, create a call to the Remote Office router:

```
ADD ISDN CALL=ROHO OUTSUB=LOCAL
    SEARCHSUB=LOCAL NUMBER=1234567 PREC=IN
```

On the Remote Office router, create a call to the Head Office router:

```
ADD ISDN CALL=ROHO OUTSUB=LOCAL
    SEARCHSUB=LOCAL NUMBER=9876543
    PREC=OUT
```

Each call has the same name (ROHO), and this name is passed via the called subaddress IE to provide identification to the remote end of the link. Each router will search for this call using the called subaddress IE.

The precedence must be set to ensure that in the event of a call collision (the same call being made and answered at the

same time), one call is completed and other call is cleared. The direction of precedence is not important, but it must be set to IN at one end of the call and OUT at the other end of the call.

The ISDN number is the exact sequence required to reach the remote router from the local router, including STD access codes and area codes. The number may contain only decimal digits. Hyphens and other characters will result in an error.

Check that the ISDN calls have been successfully added with the command:

```
SHOW ISDN CALL
```

6 Create PPP interfaces to use the ISDN calls. PPP provides the link layer protocol and enables multiple network and transport layer protocols such as IP and Novell® IPX to be carried over the same ISDN link.

For example, on the Head Office router create PPP interface 0 to use the ISDN call ROHO:

```
CREATE PPP=0 OVER=ISDN-ROHO
```

On the Remote Office router, create PPP interface 0 to use the ISDN call ROHO:

```
CREATE PPP=0 OVER=ISDN-ROHO
```

Check the configuration with the commands:

```
SHOW ISDN CALL
```

```
SHOW PPP
```

The call ROHO should appear in the output of the SHOW ISDN CALL command. The output of the SHOW PPP command should show interface ppp0 over ISDN-ROHO.

ISDN is now ready to be used by routing protocols such as IP and IPX.

CONFIGURING PRIMARY RATE ISDN

To configure Primary Rate ISDN on the AR740 router, follow these steps:

I The AR740 can operate in either TE or NT mode, using 75Ω or 120Ω termination. The router is shipped with jumpers set to TE mode, 75Ω termination, Tx grounded and Rx grounded via a 100nF capacitor. This is appropriate for most situations. Your distributor or reseller can advise you whether or not grounding jumpers should be installed.

Warning: Disconnect the router from the mains power supply before removing the router lid.

2 Select the country in which the router is being operated, using the command:

```
SET SYSTEM TERRITORY={AUSTRALIA|CHINA|
EUROPE|JAPAN|KOREA|NEWZEALAND|USA}
```

The territory determines which Q.931 profile is used on the ISDN interface. For example, to select the Q.931 profile for New Zealand, use the command:

```
SET SYSTEM TERRITORY=NEWZEALAND
```

Warning: If you are not sure which territory to use, contact your distributor or reseller. Failure to select the correct territory will invalidate the approval of this product with respect to the applicable national standards for the country in which the product is used.

3 The router's ISDN directory numbers and subaddresses may be set with the command:

```
SET Q931=0 NUM1=number NUM2=number
SUB1=subaddress SUB2=subaddress
```

This step is only required if the router is sharing the ISDN S/T bus with other ISDN devices. See the *AR Series Router Software Reference* for more information.

4 Create ISDN call definitions to enable the router to make ISDN calls to other devices on the ISDN network. This is the only step that must be completed to configure ISDN on the router. Before a call can be made from one router to another, call definitions must be created on both routers, using the command:

```
ADD ISDN CALL=name NUMBER=number
PRECEDENCE={IN|OUT} options...
```

For example, a Remote Office router is to be connected to the Head Office router via ISDN. The ISDN number of the Remote Office router is 1234567. The ISDN number of the Head Office router is 9876543. The *called party subaddress information element* (IE) is used to carry connection information, and PPP interfaces will be created explicitly to use the ISDN calls. Either router can initiate the call, but calls from the Remote Office have precedence. On the Head Office router, create a call to the Remote Office router:

```
ADD ISDN CALL=ROHO OUTSUB=LOCAL
SEARCHSUB=LOCAL NUMBER=1234567 PREC=IN
```

On the Remote Office router, create a call to the Head Office router:

```
ADD ISDN CALL=ROHO OUTSUB=LOCAL
SEARCHSUB=LOCAL NUMBER=9876543
PREC=OUT
```

Each call has the same name (ROHO), and this name is passed via the called subaddress IE to provide identification to the remote end of the link. Each router will search for this call using the called subaddress IE.

The precedence must be set to ensure that in the event of a call collision (the same call being made and answered at the same time), one call is completed and other call is cleared. The direction of precedence is not important, but it must be set to IN at one end of the call and OUT at the other end of the call.

The ISDN number is the exact sequence required to reach the remote router from the local router, including STD access codes and area codes. The number may contain only decimal digits. Hyphens and other characters will result in an error.

Check that the ISDN calls have been successfully added with the command:

```
SHOW ISDN CALL
```

5 Create PPP interfaces to use the ISDN calls. PPP provides the link layer protocol and enables multiple network and transport layer protocols such as IP and Novell® IPX to be carried over the same ISDN link.

For example, on the Head Office router create PPP interface 0 to use the ISDN call ROHO:

```
CREATE PPP=0 OVER=ISDN-ROHO
```

On the Remote Office router, create PPP interface 0 to use the ISDN call ROHO:

```
CREATE PPP=0 OVER=ISDN-ROHO
```

Check the configuration with the commands:

```
SHOW ISDN CALL
SHOW PPP
```

The call ROHO should appear in the output of the SHOW ISDN CALL command. The output of the SHOW PPP command should show interface ppp0 over ISDN-ROHO.

ISDN is now ready to be used by routing protocols such as IP and IPX.

CONFIGURING ISDN DIAL ON DEMAND

A PPP interface that uses an ISDN call as its physical interface can be configured for dial on demand operation. The ISDN call is activated only when there is data to be transmitted, and is disconnected when the link has been idle for a period of time.

To configure ISDN dial on demand operation, follow these steps:

- 1 Complete steps 1 to 5 of *Configuring Basic Rate ISDN*, or steps 1 to 4 of *Configuring Primary Rate ISDN* above.
- 2 Create PPP interfaces to use the ISDN calls and enable the IDLE timer. Using the example in step 6 of *Configuring Basic Rate ISDN* above, on the Head Office router create PPP interface 0 to use the ISDN call ROHO:

```
CREATE PPP=0 OVER=ISDN-ROHO IDLE=ON
```

On the Remote Office router, create PPP interface 0 to use the ISDN call ROHO:

```
CREATE PPP=0 OVER=ISDN-ROHO IDLE=ON
```

Setting the IDLE parameter to ON enables the idle timer and sets the timeout period to 60 seconds. ISDN calls will be disconnected if there has been no data transmitted over the link for 60 seconds. To enable the idle timer with a different timeout period, specify a time in seconds instead of the value ON.

PPP interface 0 is now configured for dial on demand operation and any routing protocols such as IP and IPX that are configured to use PPP interface 0 will automatically inherit the dial on demand functionality.

CONFIGURING ISDN BANDWIDTH ON DEMAND

A PPP interface can be configured to use up to two B channels on an ISDN Basic Rate interface, to provide bandwidth on demand. PPP activates additional ISDN channels when the bandwidth exceeds an upper threshold, and deactivates ISDN channels as bandwidth falls below a lower threshold.

To configure an ISDN connection for bandwidth on demand operation, follow these steps:

- 1 Complete steps 1 to 5 of *Configuring Basic Rate ISDN*, or steps 1 to 4 of *Configuring Primary Rate ISDN* above.
- 2 Create a second ISDN call on each router, identical to the call ROHO but with the name DEMAND.
- 3 Create PPP interfaces to use the ISDN calls, enable the IDLE timer and add a second demand channel. Using the example in step 6 of *Configuring Basic Rate ISDN* or step 5 of *Configuring Primary Rate ISDN* above, on the Head Office router create PPP interface 0:

```
CREATE PPP=0 OVER=ISDN-ROHO IDLE=ON
ADD PPP=0 OVER=ISDN-DEMAND TYPE=DEMAND
```

On the Remote Office router, create PPP interface 0:

```
CREATE PPP=0 OVER=ISDN-ROHO IDLE=ON
ADD PPP=0 OVER=ISDN-DEMAND TYPE=DEMAND
```

PPP interface 0 is now configured for bandwidth on demand operation and any routing protocols such as IP and IPX that are configured to use PPP interface 0 will automatically inherit the bandwidth on demand functionality.

Configuring an IP Network

TCP/IP is the most widely used network protocol. The Internet uses TCP/IP for routing all its traffic. TCP/IP provides a range of services including remote login, Telnet, file transfer (FTP), Email and access to the World-Wide Web.

The AR740 router routes TCP/IP across the wide area network using services like ISDN, Frame Relay and leased lines, enabling remote TCP/IP LANs to be joined together as a single internet to exchange information.

This example illustrates the steps required to configure TCP/IP using the router's command line interface. Two routers running TCP/IP will be connected together using the Point-to-Point

Protocol (PPP) over a wide area link. Each router is attached to an Ethernet LAN on which there is a mixture of PCs and hosts.

BEFORE YOU START

- 1 Ensure that the routers to be configured are connected to the Ethernet LAN and the wide area link, and that the link is operational. See *Getting Connected* for information about connecting the router to a physical network.
- 2 Connect a terminal to the console port (port 0) on each router, as described in the *AR700 Series Router Quick Install Guide*. Alternatively, you can connect a PC to the console port

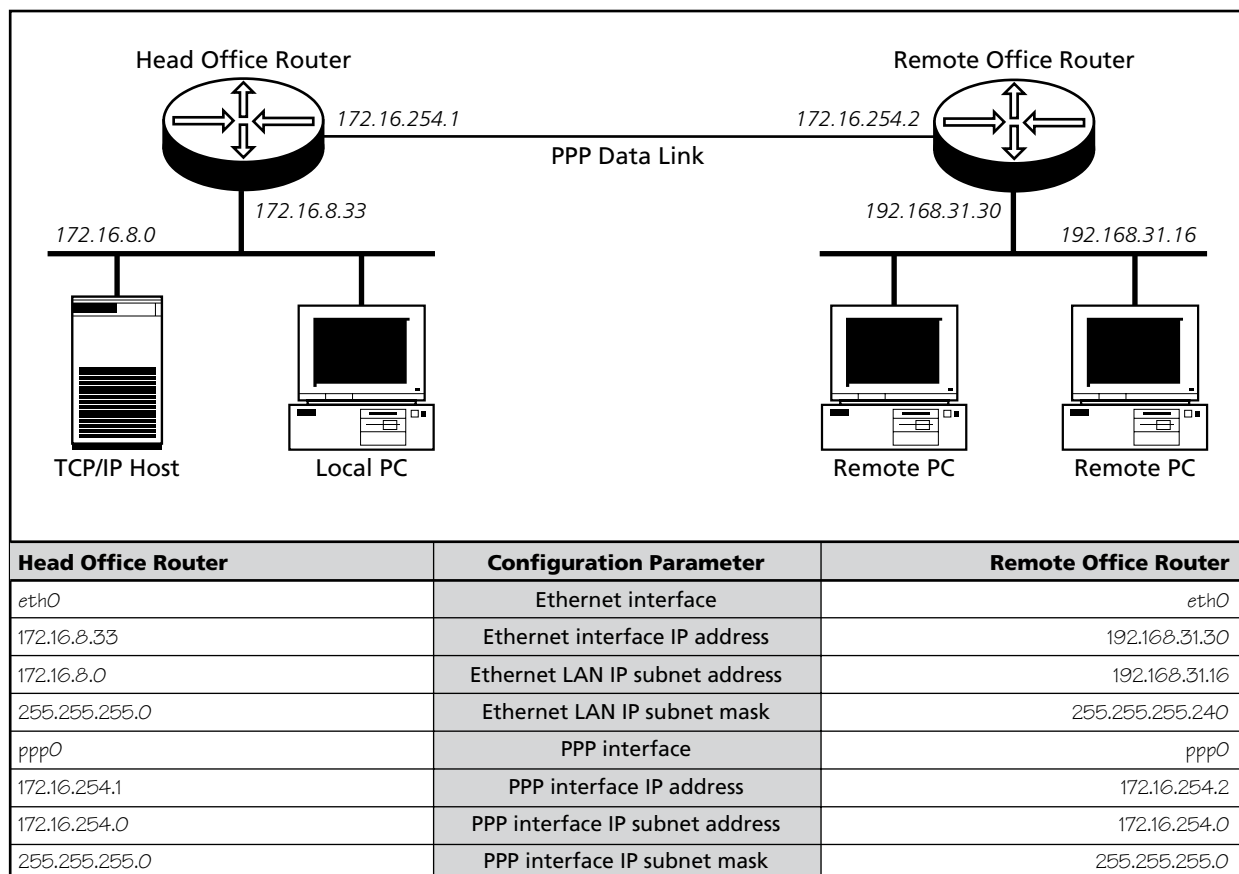

and use a terminal emulation program like Windows™ Terminal.

3 Login to the MANAGER account on each router, as described in the *AR700 Series Router Quick Install Guide*.

4 Collect together the information that you will need to configure IP. We recommend you photocopy the table on the previous page and fill in the details.

CONFIGURING IP

The following steps are required:

1. Configure the PPP Link.
2. Configure the IP routing module on both routers.
3. Test the configuration.

Configure the PPP Link

Configure PPP interface 0 on each router to use the wide area link. See *Getting Connected* for information about configuring PPP to use a synchronous link. See *Configuring ISDN* for information about configuring PPP to use an ISDN call. If the PPP interface is configured for dial on demand operation (see *Configuring ISDN Dial on Demand*) or bandwidth on demand operation (see *Configuring ISDN Bandwidth on Demand*), these services will automatically be used by the IP routing software.

Configure IP Routing

1 Clear any pre-existing IP configuration and turn on the IP routing software on each router, using the commands:

```
PURGE IP
ENABLE IP
```

2 On the Head Office router define two IP interfaces, one for the Ethernet LAN and one for the wide area link:

```
ADD IP INT=ETH0 IP=172.16.8.33
    MASK=255.255.255.0
ADD IP INT=PPP0 IP=172.16.254.1
    MASK=255.255.255.0
```

3 Repeat this procedure on the Remote Office router, defining one IP interface for the Ethernet LAN and one for the wide area link:

```
ADD IP INT=ETH0 IP=192.168.31.30
    MASK=255.255.255.240
ADD IP INT=PPP0 IP=172.16.254.2
    MASK=255.255.255.0
```

4 A routing protocol, such as RIP, can be enabled so that the routers can exchange information about routes to all of the IP devices (hosts, PCs, file servers, etc.) on the internet. However,

on a dial-on-demand ISDN connection this may result in excessive call charges. So for this example static routes will be defined. On the Head Office router enter the command:

```
ADD IP ROUTE=192.168.31.0
    MASK=255.255.255.240 INT=PPP0
    NEXT=172.16.254.2
```

5 Repeat this procedure for the Remote Office router, entering the command:

```
ADD IP ROUTE=172.16.8.0
    MASK=255.255.255.0 INT=PPP0
    NEXT=172.16.254.1
```

6 The IP routing software is now configured and operational on both routers.

Test the Configuration

The IP configuration can now be checked using the following commands and then functionally tested by establishing a Telnet (remote access) connection to the remote router.

1 To check the routes, type (on either router):

```
SHOW IP ROUTE
```

This should produce a display (on the Head Office router) like that shown on page 19. For each router, there should be a route to the LAN and PPP interfaces on the local router and a route to the LAN interface on the remote router.

2 Test the PPP link between the two routers using the PING command on each router to send ping packets to the router at the remote end of the PPP link. On the Head Office router use the command:

```
PING 192.168.31.30
```

On the Remote Office router use the command:

```
PING 172.16.8.33
```

Within a few seconds the router will display a message like:

```
Echo reply 1 from 172.16.8.33 time delay
    20 ms
```

indicating a response was received from the router at the remote end of the PPP link.

Note: We have used the Ethernet address in this example but you can ping any of the remote router's assigned IP addresses.

3 To functionally test the connection between the two routers, use Telnet to establish a connection to the remote router. Enter the following command on the Head Office router to connect to the Remote Office router:

```
TELNET 192.168.31.30
```

Example output from the `SHOW IP ROUTE` command for a basic TCP/IP network.

IP Routes						
Destination DLCI/Circ.	Mask Type	Policy	Nexthop Protocol	Interface Metric	Age	Preference
172.16.8.0	255.255.255.0		0.0.0.0	eth0		1382
-	direct	0	interface	1		0
172.16.31.16	255.255.255.240		172.16.254.2	ppp0		71
-	remote	0	static	2		100
172.16.254.0	255.255.255.0		0.0.0.0	ppp0		1382
-	direct	0	interface	1		0

Example output from the `SHOW PPP` command for a basic TCP/IP network.

Name	Enabled	ifIndex	Over	CP	State
ppp0	YES	04		IPCP	OPENED
			isdn-roho	LCP	OPENED

You will see the login screen for the Remote Office router. To connect from the Remote Office router to the Head Office router, on the Remote Office router use the command:

```
TELNET 172.16.8.33
```

Note: We have used the Ethernet address in this example but you can Telnet to any of the remote router's assigned IP addresses.

Save the Configuration

Save the new dynamic configuration as a script, by entering the command:

```
CREATE CONFIG=IPCONF.SCP
```

TROUBLESHOOTING IP CONFIGURATIONS

No Route Exists to the Remote Router

1 Wait for at least one minute to ensure that a RIP update has been received.

2 Repeat steps 4 and 5 above. Check that the PPP link is OPENED for both LCP and IP by entering the command:

```
SHOW PPP
```

The display should look like that shown above.

3 Try restarting the IP routing software (a warm restart), by entering the command:

```
RESET IP
```

If the route still does not appear, contact your distributor or reseller for assistance.

Telnet Fails

1 If Telnet to a router fails, check that the IP address you used matches the one assigned to the router. Check that RIP is configured correctly (steps 4 and 5 above). Check that the IP Telnet server is enabled on each router, using the command:

```
SHOW IP
```

If the Telnet server is disabled, enable the Telnet server with the command:

```
ENABLE IP TELNETSERVER
```

2 If Telnet into a host on the remote LAN fails, but works into the remote router, check the IP address you are using is correct. Check that both routers are gateways, not servers by typing:

```
SHOW IP
```

The "IP Packet Forwarding" field in the output should be set to "Enabled". The host's TCP/IP software should be configured to use the Head Office router as its gateway. Refer to the documentation for the host TCP/IP software for more information about configuring a gateway.

3 Contact your distributor or reseller for assistance.

Configuring a Novell IPX Network

This example illustrates the steps required to configure a pair of AR740 routers to create a Novell® IPX internetwork, using the router's command line interface. In this scenario, PCs at a remote office need access to a Novell file server at the Head Office site. The two sites are connected by a PPP link over a wide area link—either a dedicated leased line or an ISDN call.

BEFORE YOU START

1 Ensure that the routers to be configured are connected to the wide area link, and that the wide area link is operational. See *Getting Connected* for information about connecting the router to different physical networks.

2 Connect a terminal to the console port (port 0) on each router, as described in the *AR700 Series Router Quick Install Guide*. Alternatively, you can connect a PC to the console port and use a terminal emulation program like Windows™ Terminal, or Telnet to the routers using a Telnet client. To use Telnet both routers must be configured for IP. See *Configuring an IP Network* for details.

3 Login to the MANAGER account on each router, as described in the *AR700 Series Router Quick Install Guide*.

4 Collect the information that you will need to configure IPX. We recommend you photocopy the table below and fill in the details. Pay particular attention to the following points:

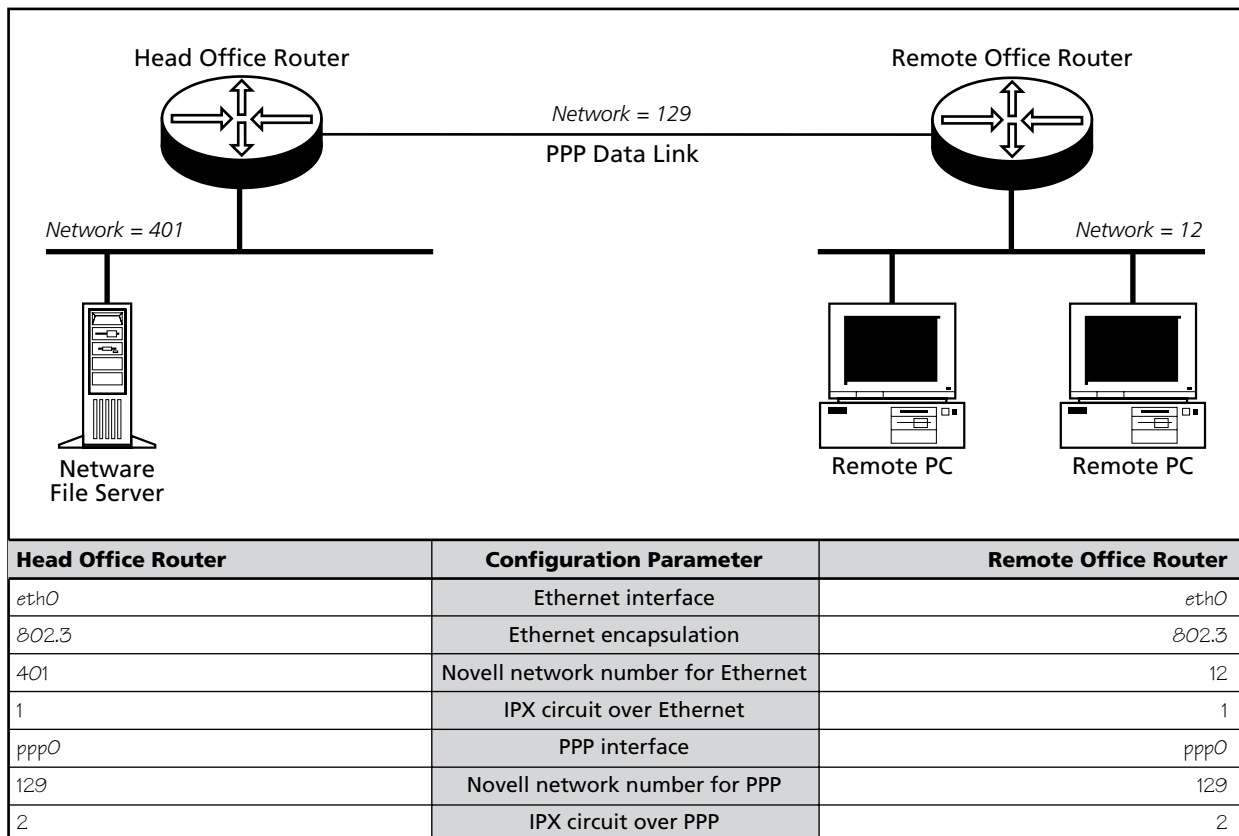

- Each network in a Novell internet, including all LANs and WAN links, must be assigned a network number. Novell file servers also have an internal network number. These network numbers must be unique across the Novell internet—no two networks or file servers may use the same network number. All devices attached to a network must use the same network number to refer to the network. Check to see what numbers your file servers are using. Many schemes exist to ensure that numbers are kept unique, for example, using the hexadecimal representation of the IP address or the telephone number of each location.
- All routers, file servers and workstations attached to an Ethernet LAN must use the same Ethernet encapsulation or frame type. The following table lists the Novell frame type and the equivalent AR router encapsulation:

Novell Frame Type	Router Encapsulation
Ethernet_802.3	802.3
Ethernet_802.2	802.2
Ethernet_II	EthII
Ethernet_SNAP	SNAP

You can determine the file server name, internal network number, Ethernet frame type and Ethernet network number used by a Novell file server, by interrogating the file server itself. From the management console attached to the Novell file server, at the system console prompt type the command “config” and record the values of the fields “File server name”, “IPX internal network number”, “Frame type” and “LAN protocol”. You can also access the system console by running the rconsole utility from any workstation logged in as supervisor. For more details, contact your local Novell network administrator or refer to the Novell documentation.

CONFIGURING IPX

The following steps are required:

1. Configure the PPP link.
2. Configure the routers for IPX.
3. Test the configuration.

Configure the PPP Link

Configure PPP interface 0 on each router to use the wide area link. See *Getting Connected* for information about configuring PPP to use a synchronous link. See *Configuring ISDN* for information about configuring PPP to use an ISDN call. If the

PPP interface is configured for dial on demand operation (see *Configuring ISDN Dial on Demand*) or bandwidth on demand operation (see *Configuring ISDN Bandwidth on Demand*), these services will automatically be used by the IPX routing software.

Configure IPX Routing

1 Purge the IPX static database to clear any preexisting IPX configuration and enable the IPX routing software on each router, using the commands:

```
PURGE IPX
ENABLE IPX
```

2 On the Head Office router define two IPX circuits, one for the Ethernet interface and one for the wide area link, using:

```
ADD IPX CIRC=1 INT=ETH0 NETW=401
    ENCAP=802.3
ADD IPX CIRC=2 INT=PPP0 NETW=129
```

3 Repeat this procedure on the Remote Office router, defining one IPX circuit for the Ethernet interface and one for the wide area link, using:

```
ADD IPX CIRC=1 INT=ETH0 NETW=12
    ENCAP=802.3
ADD IPX CIRC=2 INT=PPP0 NETW=129
```

4 The routers are now configured for IPX and can exchange routes and service information.

Test the Configuration

1 Examine the route table and service table on each router, using the commands:

```
SHOW IPX ROUTE
SHOW IPX SERVICE
```

The route table will contain paths from each Novell device which advertises routes, for example file servers and routers. The service table lists all the services, such as file services and print services, that devices are advertising.

Note: The actual contents of the table varies with the number and type of file servers present on the network, but there should be a route from each router to the other, and all services shown as local (i.e. via eth0) on one router, should also be visible on the other router, via the PPP link.

2 Test that a workstation on the Remote Office LAN can login to the file server on the Head Office LAN.

Example output from the `SHOW IPX ROUTES` command for a basic Novell IPX network.

IPX routes						
Network	Nexthop	Circuit	Hops	Cost	Uptime	Type
00000401	Local	1 (eth0)	1	1	85973	Local
00000129	Local	2 (ppp0)	1	1	85973	Local
00000012	00000129:0000cd000d26	2 (ppp0)	2	1	85973	RIP

Example output from the `SHOW IPX SERVICES` command for a basic Novell IPX network.

IPX services					
Name	Address	Server type	Circuit	Hops	Age Defined
ACCOUNTS	00007500:000000000001:0451	0004:FileServer	1 (eth0)	1	SAP 0
ACCOUNTS	00007500:000000000001:8104	0107:RConsole	1 (eth0)	1	SAP 0
TYPISTS	00000012:0080488018d8:0451	0004:FileServer	2 (ppp0)	3	SAP 0

Example output from the `SHOW PPP` command for a basic Novell IPX network.

Name	Enabled	ifIndex	Over	CP	State
ppp0	YES	04		IPXCP	OPENED
			isdn-roho	LCP	OPENED

Save the Configuration

Save the new dynamic configuration as a script, by entering the command:

```
CREATE CONFIG=IPXCONF.SCP
```

TROUBLESHOOTING IPX CONFIGURATIONS

No Routes are Visible to the Remote Router

- 1 Check the PPP link is active, using the command:

```
SHOW PPP
```

The display should look like that shown above. The state of the IPX control protocol (IPXCP) should be "OPENED". If not, then the fault lies with the connection between the two routers, or the PPP configuration at either end of the link.

- 2 Check that the IPX circuits are correctly configured on each router by repeating steps 1 through 3 above, or by typing:

```
SHOW IPX CIRCUIT
```

Check that there are two circuits, and for each circuit check that the circuit is enabled, uses the correct interface and

encapsulation (for Ethernet interfaces), the network number is correct and "On demand" is set to "no". If not, then repeat steps 1 through 3.

- 3 Contact your distributor or reseller for assistance.

Local Workstations Can Not Access Remote Servers

This problem can be caused by a number of different events. The following give some of the most common:

- 1 Check that when the workstation is moved to the same LAN as the file server, it is able to access the server. If not, the fault lies with the configuration of the workstation or file server. Check with your Novell network administrator.
- 2 Care must be taken with the workstation NET.CFG file. Always specify the encapsulation (frame) as different LAN card drivers use different default encapsulations.
- 3 Does the file server appear in the IPX service table of the Remote Office router? If the server does not appear in the table, its presence can not be advertised to the local LAN. Check this by typing:

```
SHOW IPX SERVICE
```

This should produce a display like that shown on the previous page. The important point is that the file server must appear in the service table on the Remote Office router and there must be a route to the file server's internal network number. If there is, and it still does not work, contact your distributor or reseller for assistance.

4 Check the route tables on both routers, using the command:

```
SHOW IPX ROUTE
```

Check for the presence of networks on the remote side of the wide area network. If the remote network is missing from the route table on either router, use the command:

```
RESET IPX
```

which resets the IPX routing software and forces the routers to broadcast their routing and service tables.

CONFIGURING IPX DIAL ON DEMAND

If the PPP link uses an ISDN call and has been configured as a dial on demand link (see *Configuring ISDN Dial on Demand* earlier in this guide), then IPX can be configured for IPX dial on demand services.

To configure IPX dial on demand, follow these steps:

1 Purge the IPX static database to clear an preexisting IPX configuration and enable the IPX routing software on each router, using the commands:

```
PURGE IPX
ENABLE IPX
```

2 On the Head Office router define two IPX circuits, one for the Ethernet interface and one for the wide area link. Configure the wide area link as a demand link and enable RIP and SAP change broadcasts, using:

```
ADD IPX CIRC=1 INT=ETH0 NETW=401
ENCAP=802.3
ADD IPX CIRC=2 INT=PPP0 NETW=129
DEMAND=ON
SET IPX CIRC=2 RIPCHANGE=YES
SAPCHANGE=YES
```

3 Repeat this procedure on the Remote Office router, defining one IPX circuit for the Ethernet interface and one for the wide area link. Configure the wide area link as a demand link and enable RIP and SAP change broadcasts, using:

```
ADD IPX CIRC=1 INT=ETH0 NETW=12
ENCAP=802.3
ADD IPX CIRC=2 INT=PPP0 NETW=129
DEMAND=ON
SET IPX CIRC=2 RIPCHANGE=YES
SAPCHANGE=YES
```

4 The routers are now configured for IPX dial on demand and can exchange routes and service information. Save the new dynamic configuration as a script, by entering the command:

```
CREATE CONFIG=IPXDOD.SCP
```

The link will be activated (the ISDN call will be connected) whenever there is data waiting to be transmitted over the wide area link, and deactivated when there has been no data transmitted over the link for a period of time. The link will also be activated whenever there is a change of route or service information, to allow the exchange of RIP and SAP updates. To improve performance, RIP and SAP filters can be configured on the Head Office router to limit the number and size of broadcasts which activate the ISDN call.

To configure RIP and SAP filters, follow these steps on the Head Office router only:

1 Create a RIP filter that only allows information about route changes to the file server's internal network (network number 7500) to be included in RIP broadcasts:

```
ADD IPX RIP=0 NET=7500 ACTION=INCLUDE
```

2 Create a SAP filter that only allows information about the file services provided by the file server (named ACCOUNTS) to be included in SAP broadcasts:

```
ADD IPX SAP=0 SERVICE=ACCOUNTS TYPE=FILE
ACTION=INCLUDE
```

3 Associate the RIP and SAP filters with the IPX circuit over the PPP link:

```
SET IPX CIRC=2 RIPCHANGE=YES
SAPCHANGE=YES OUTRIP=0 OUTSAP=0
```

4 Save the new dynamic configuration as a script, by entering the command:

```
CREATE CONFIG=IPXFILT.SCP
```