

AT-8700XL SERIES

HARDWARE REFERENCE

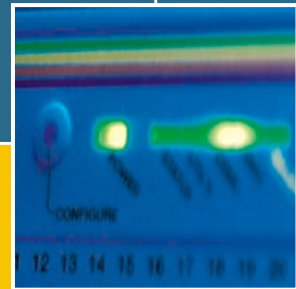
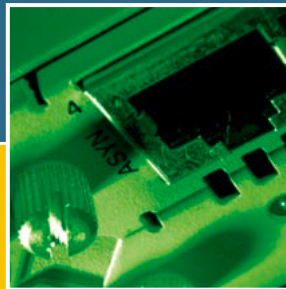
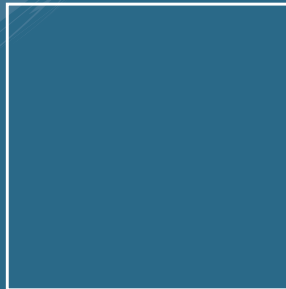

AT-8700XL Series Hardware Reference
Document Number C613-03064-00 REV A.

Copyright © 2002 Allied Telesyn International, Corp.
19800 North Creek Parkway, Suite 200, Bothell, WA 98011, USA.

All rights reserved. No part of this publication may be reproduced without prior written permission from Allied Telesyn.

Allied Telesyn International, Corp. reserves the right to make changes in specifications and other information contained in this document without prior written notice. The information provided herein is subject to change without notice. In no event shall Allied Telesyn be liable for any incidental, special, indirect, or consequential damages whatsoever, including but not limited to lost profits, arising out of or related to this manual or the information contained herein, even if Allied Telesyn has been advised of, known, or should have known, the possibility of such damages.

All trademarks are the property of their respective owners.

Contents

Models Covered By This Reference	2
Why You Should Read This Reference	2
Where To Find More Information	3
Hardware Description	3
Switch Overview	3
AT-8700XL Series Switch Models	5
AT-8724XL	5
AT-8748XL	5
Online Documentation	6
Accessing the CD-ROM and Online Documentation	6
AT-TFTP Server	6
Switch Start-up	8
To Log In	8
To access help files	8
Start-up Procedures	9
Switch Interfaces	11
RS-232 Terminal Port	11
Switch RJ-45 Ports	12
Redundant Power Supply	14
Switch Cables and Loopback Plugs	15
Terminal and Modem Cables	15
Loopback Plugs for Testing Switch Interfaces	17
Test Facility	17
10/100 Ethernet LAN Port Tests	18
Troubleshooting	18
LEDs and What They Mean	19
Expansion Options	23
Uplink Modules	23
Port, Connector, and Cable Combinations	24
Using Windows Terminal and Windows Hyperterminal	24
Restricted Procedures	27
Diagnostics	27
Replacing Boot EPROMs	28
Troubleshooting EPROM Installation	30
Contacting Us	31

Documentation Roadmap

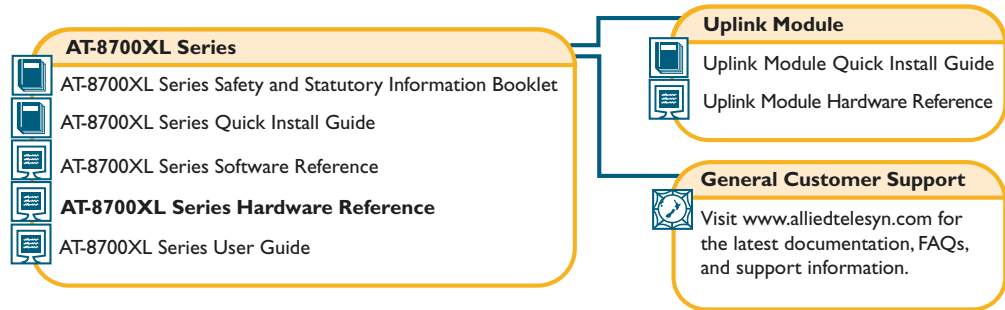

Printed



Acrobat PDF



Website

Models Covered By This Reference

This Hardware Reference includes information on the following models:

- AT-8724XL 24-port 10BASE-T/100BASE-TX Advanced Fast Ethernet Switch
- AT-8748XL 48-port 10BASE-T/100BASE-TX Advanced Fast Ethernet Switch

The latest Hardware Reference can be found at www.alliedtelesyn.com.

Why You Should Read This Reference

This Reference has been developed to familiarise you with AT-8700XL Series switches and their hardware features. The information found in this Reference will assist you with the process of installing and maintaining your AT-8700XL Series switch.

The Reference also introduces Uplink Module expansion options. Detailed information on Uplinks can be found in the *Uplink Module Hardware Reference*, which is included on the AT-8700XL Series Documentation and Tools CD-ROM, or can be downloaded from www.alliedtelesyn.com.



Keep this Reference (or its CD-ROM) in a safe place, you will need it if you purchase switch expansion options in the future.



This Reference does not cover software configuration or software installation procedures. For information on software, refer to the AT-8700XL Series Software Reference.

Where To Find More Information

The Documentation and Tools CD-ROM bundled with each AT-8700XL Series switch contains the complete Document Set for your switch and its expansion options, as well as tools for managing the switch. This includes:

- The *AT-8700XL Series Safety Booklet*, which provides safety and statutory information.
- The *AT-8700XL Series Quick Install Guide*, which outlines the procedure for installing switch units; and this *AT-8700XL Series Hardware Reference*.
- The *AT-8700XL Series Software Reference*, which provides detailed information on configuring the switch and its software.
- The *Uplink Module Quick Install Guide*, which outlines the procedure for installing an Uplink Module; and the *Uplink Module Hardware Reference*, which provides detailed information on Uplink Modules.
- AT-TFTP Server for Windows, for downloading software releases.
- Adobe Acrobat Reader, for viewing online documentation.
- Microsoft Internet Explorer.

These documents can also be downloaded from the www.alliedtelesyn.com.

Hardware Description

This section provides an overview of the hardware features for AT-8700XL Series switches. Hardware descriptions for Uplink Modules can be found in the *Uplink Module Hardware Reference*. These references can be found on the CD-ROM bundled with your switch, or can be downloaded from www.alliedtelesyn.com.

Switch Overview

AT-8700XL Series switches deliver low-latency high-bandwidth wire-speed Layer 2 and 3 switching to the desktop. RJ-45 copper ports ensure industry-standard compatibility, while two gigabit uplink module bays add expansion and configuration flexibility.

Dimensions

- Height = 66 mm (plus 5.5 mm if the rubber feet are used)
- Width = 440 mm (excluding rack-mounting brackets)
- Depth = 360 mm
- Weight = Not more than 7 kg, depending on model (excluding power cord)

Mounting System

- 1.5U rack mounting

Environmental Conditions

- Operating temperature range: 0 to 40° C (32 to 104° F)
- Storage temperature range: -25 to 70° C (-13 to 158° F)
- Relative humidity range: 5 to 95% non-condensing

Regulatory Standards

- EMC: CISPR22 class A, FCC class A, and VCCI class I
- Immunity testing to EN50082 levels 2 (ESD), 3 (susceptibility), 4 (fast transients), 5 (power surge), and 6 (RF immunity)
- Safety: UL1950, CSA22.2, EN60950

LEDs

- Ethernet port and System status LEDs
- For a complete list of LEDs and their functions, see “Fault Indicators and What They Mean” on page 24.

Power Supply Unit

AC models

- Universal 110/240 VAC 50/60 Hz input
- Redundant DC Power connection

DC models

- 48VDC (36-59VDC is acceptable)
- Accepts positive or negative earthing (grounding)

Switching Core

- Advanced ASIC switch chip
- Wire-speed L2 and L3 IP Switching

Processing Core

- 200 MHz RISC Processor
- 32 MBytes Synchronous DRAM
- 8 MBytes flash memory
- 128 KBytes Non-volatile Storage (battery backed SRAM)

Asynchronous Serial Port

- Up to 115 kbps
- Standard DB9 female RS-232 connector
- Hardware-flow control

Uplink Module Bays

- 2 very high performance bays
- Support for gigabit Ethernet uplink modules

AT-8700XL Series Switch Models

This section provides hardware descriptions for individual switch models.

AT-8724XL

(Figure 1 on page 5)

- 24-port 10BASE-T/100BASE-TX (RJ-45 connectors)
- Two 10/100/1000BASE uplink bays
- Auto-negotiating Advanced Fast Ethernet Switch
- Enhanced 5615 switching core

Figure 1: Front panel of the AT-8724XL.

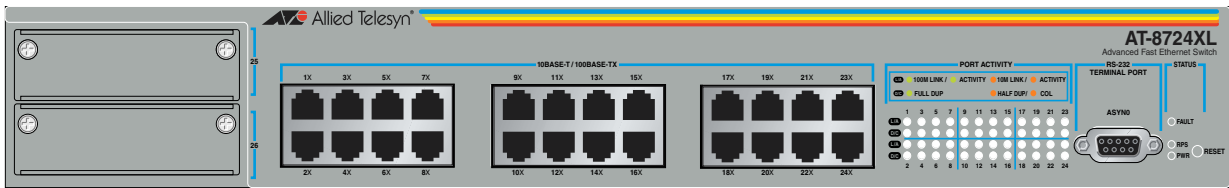

AT-8748XL

(Figure 2 on page 5)

- 48-port 10BASE-T/100BASE-TX (RJ-45 connectors)
- Two 10/100/1000BASE uplink bays
- Auto-negotiating Layer 3 Advanced Fast Ethernet Switch
- Enhanced 5615 switching core

Figure 2: Front panel of the AT-8748XL.

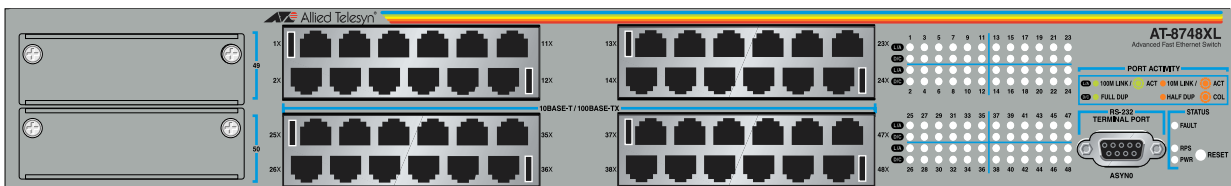

Online Documentation

This section provides a step-by-step guide to accessing online documentation. Adobe Acrobat Reader must be installed to view online documentation.

Accessing the CD-ROM and Online Documentation

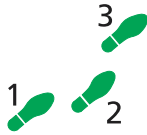

Follow these steps to access the CD-ROM and online documentation:

1. Insert the AT-8700XL Series Documentation and Tools CD-ROM in the CD-ROM drive.

2. If the Welcome screen does not appear.

Select "Run" from the Start Menu (Windows 95, 98, 2000 or NT 4.0).

Type d:\start.exe (where d: is the CD-ROM drive letter) and click OK.

3. To view a document.

Click on the document title.

4. To navigate around PDF documents.

Use the toolbar buttons, keyboard shortcuts, or commands from the Document menu to page through the document.

Click on a bookmark, thumbnail or hypertext link to jump to a specific section or topic.

Use the Search command to search for keywords or phrases.

For more information about using the Adobe Acrobat Reader, select "Reader Guide" from the Help menu.

5. To install any of the tools included on the CD-ROM.

Click on a link in the Welcome screen.

AT-TFTP Server

This section provides information on how to access and use AT-TFTP Server. AT-TFTP Server can be used to transfer configuration files as well as to download software patches and releases.

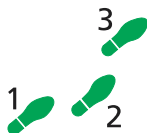

To use AT-TFTP Server, follow these steps:

1. If AT-TFTP Server has not yet been installed.

Install it now from the AT-8700XL Series Documentation and Tools CD-ROM.

Choose AT-TFTP Server from the Start > Programs > Allied Telesyn > AT-TFTP Server menu.

2. To set preferences for the AT-TFTP Server.

Select "Options" from the File menu to display the "Set Preferences" dialog box.

The "Default file transfer directory" field specifies the directory that AT-TFTP Server will read from or write to for file requests that do not include a directory specification.

To prevent unauthorised access to private directories, enter a path name in the "Restrict to directory" field. AT-TFTP Server will use only the specified directory, even if file requests contain references to other directories.

Select "Read only" to prevent files being written to the PC. To use the PC to archive scripts created using the switch's CREATE CONFIG command, select "Read Write".

Make any required changes and click "OK".

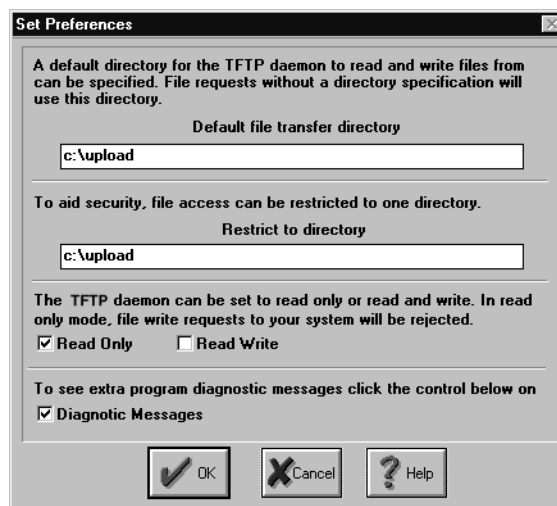

3. To load a file from AT-TFTP Server to the Switch.

On a terminal connected to the switch, type the command:

```
LOAD METHOD=TFTP FILE=filename SERVER=ipadd DEST=FLASH
```

where *filename* is the name of the file to download and *ipadd* is the IP address of the PC running AT-TFTP Server.

4. To save a TFTP Server log.

Select "Save As" from the File menu.

TFTP requests are logged to the AT-TFTP Server main window.

Switch Start-up

This section outlines the log in and start-up procedures for your switch. Although the switch will perform basic switching operations without being configured, you will need to go through these log in and start-up procedures if you wish to configure the switch and access its full switching capabilities.

To Log In

Using the supplied RS-232 DB9 straight-through cable, connect your terminal or PC to the RS-232 Terminal Port on the switch's front panel.

Set the communication parameters on your terminal or terminal emulation program to:

- Baud rate: 9600
- Data bits: 8
- Parity: None
- Stop bits: 1
- Flow control: Hardware

See "Using Windows Terminal and Windows Hyperterminal" on page 37 for more information on configuring emulation software.

After the switch has booted, the log in prompt appears. If the log in prompt doesn't appear, press [Enter] two or three times.

When the switch boots for the first time it automatically creates an account with manager privileges. The account has the log in name "manager" and the password is "friend".

At the log in prompt, enter the log in name and password.

```
Log in: manager
```

```
Password: friend
```

The switch's command prompt appears and you can now configure the switch using the command line interface.



Change the password as soon as possible. Leaving the manager account with the default password is a serious security risk. Make sure that you remember the new password as there is no way to retrieve it if it is lost.

Use the following command to change the account password:

```
set password
```

See the *AT-8700XL Series Software Reference* for more information on configuring the switch.

To access help files

Before help is used for the first time, the help files must be defined.

To define the files, enter:

```
set help=help-filename
```

where *help-filename* is the name of a help file stored in flash.

To see a list of files stored in flash, enter:

```
show file
```

Help files have an HLP extension.

To display a list of help topics, enter:

```
help
```

To display help on a specific topic, enter:

```
help topic
```

Alternatively, type a question mark (?) at the end of a partially completed command to see a list of valid options.

Start-up Procedures

When the switch starts up following either a power cycle or an operator-initiated reboot (using the Reset button or RESTART command), a series of start-up messages is sent to the RS-232 Terminal Port (Figure 3 on page 9).

Figure 3: Switch start-up messages.

```
INFO: Self tests beginning.
INFO: RAM test beginning.
PASS: RAM test, 32768k bytes found.
INFO: BBR tests beginning.
PASS: BBR test, 128k bytes found.
INFO: Self tests complete
INFO: Downloading switch software.
Force EPROM download (Y) ?
INFO: Initial download succeeded
INFO: Executing configuration script <boot.cfg>
INFO: Switch startup complete

Manager >
```

After the self tests are complete, the manager is given the option of forcing a mandatory boot from the EPROM release. The message:

```
Force EPROM download (Y)?
```

is displayed on the terminal connected to the RS-232 Terminal Port and the switch pauses. If a key is not pressed within a few seconds, the start-up process will continue and all steps in the sequence will be executed. Pressing selected keys on the terminal immediately after the “Force EPROM download” message is displayed will change the switch start-up process (Table 1 on page 9).

Table 1: Switch start-up sequence keystrokes.

Pressing key...	Forces the switch to...
[Y]	Load the EPROM release, with no patch.
[S]	Start with the default configuration. Any boot script is ignored.
[Ctrl/D]	Enter diagnostics mode.

During the start-up process the switch will generate four different types of messages. All messages are preceded by one of the words INFO, PASS, FAIL, or ERROR. The significance of these words is shown in Table 2 on page 10.

Table 2: Switch start-up message classes.

Message	Meaning
INFO	An action will be taken by the system.
PASS	A test has been completed successfully.
ERROR	An error message that a test has failed, but the system will continue to operate.
FAIL	An error message that a fatal error condition has caused the system to halt in an unrecoverable fashion.

The possible messages and their meanings are:

INFO: Self tests beginning.

The code loader tests are about to begin.

INFO: RAM test beginning.

The RAM tests are about to begin.

PASS: RAM test, 32768k bytes found.

The RAM test passed, and the indicated amount of memory was found and will be used in the switch.

ERROR: RAM test 5. Error address = 00345678.

A RAM test failed, at the given address. In the example, it was the fifth test run. The RAM test repeats until it passes, so a number of messages like this may appear. This fault means that the memory system is faulty. If the fault continues, contact your Authorised Allied Telesyn distributor or reseller immediately.

INFO: BBR tests beginning.

The BBR battery tests are about to begin.

PASS: BBR test. Battery OK.

The BBR battery tests passed.

ERROR: BBR Battery low.

The BBR battery test failed, indicating that the battery is running low. The BBR battery will need to be replaced. Contact your Authorised Allied Telesyn distributor or reseller.

PASS: BBR test, 256k bytes found.

The BBR size/location test passed, with the indicated amount of BBR found.

FAIL: BBR test. Error address = 12345678.

The BBR size/location test failed at the given location. The test at this location failed, indicating the end of memory, but a valid location was discovered in the 255 long words following this location. The BBR system will need to be replaced. Contact your Authorised Allied Telesyn distributor or reseller.

FAIL: BBR test, only 16k bytes found.

The BBR size/location test completed, but only the displayed amount of memory was found. This amount is less than the minimum required to run the switch software.

INFO: Self tests complete.

The start-up tests have finished.

INFO: Downloading switch software.

The process of downloading the switch software and vector table from ROM is about to begin.

ERROR: Code load retried.

FAIL: Code load failed.

The load of the code from ROM to RAM failed. The load is retried a number of times. Each time a failure occurs, the ERROR message is displayed. If the maximum number of attempts is reached, the FAIL message is displayed.

INFO: Initial download succeeded.

The start-up tests and download are complete, and the switch software is about to be started. If the default install is a compressed release, the release will now be decompressed. This may take a few seconds.

INFO: Downloading compressed release. This may take up to 1 minute...

INFO: Loading software into memory. This may take up to 1 minute...

The main switch software is about to be loaded into RAM. If the release is a compressed release, the release will be decompressed.

INFO: Executing configuration script <script-name>

The configuration commands stored in <script-name> are being executed. If an error is found in the script, one or more ERROR messages will be displayed.

INFO: Switch startup complete.

The start-up process is complete and the switch will now perform basic switching operations. Further configuration will be necessary if you wish to access the switch's full switching capabilities. See the *AT-8700XL Series Software Reference* for detailed information on configuring the switch.

Switch Interfaces

This section provides pin assignments for the switch's RS-232 Terminal Port and RJ-45 ports, and the Redundant Power Supply (RPS) connector.

RS-232 Terminal Port

The RS-232 Terminal Port is used to connect the switch to a management device. For management purposes the switch's software can be accessed from a terminal, a PC running terminal emulation software, or from a remote location via a modem connection. You can also use the RS-232 Terminal Port to establish a network connection from a remote site using SLIP and a modem.

The switch's RS-232 Terminal Port has a DCE female socket. This allows the use of a straight-through cable when connecting the switch to a terminal or PC. Output from the SHOW ASYN command will, however, still have a DTE perspective. The internal DTE pin roles are listed in Table 3 on page 12.

See Terminal and Modem Cables on page 20 for more information on connection options for the RS-232 Terminal Port.

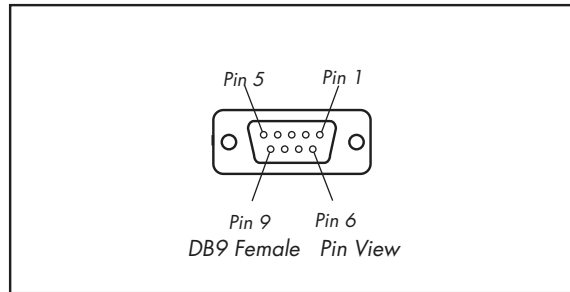
Figure 4: RS-232 Terminal Port Pin Numbers.**Table 3: Internal DTE pin roles.**

Pin	Role
2	TXD
3	RXD
4	CD
5	GND
6	DTR
7	CTS
8	RTS

Switch RJ-45 Ports



Caution. Do not plug a phone jack into any RJ-45 port. Doing so could damage the switch. Use only twisted pair cables with RJ-45 connectors.

For 10BASE-T/100BASE-TX connections, a twisted pair cable must be used. Each pair is identified by two different colours. For example, one wire might be red, and the other red with a white stripe. An RJ-45 connector must be fitted to both ends of the cable. Figure 5 on page 12 illustrates the pin layout for RJ-45 connectors.

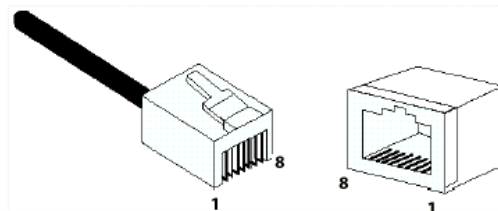
Figure 5: RJ-45 Pin layout.

With 10BASE-T/100BASE-TX cables, pins 1 and 2 are used for transmitting data, while pins 3 and 6 are used for receiving data. Table 4 on page 13 lists the RJ-45 Pin assignments.

Table 4: RJ-45 Pin assignments.

Pin Number	Assignment ¹
1	TX+
2	TX-
3	RX+
6	RX-

1. The "+" and "-" signs represent the polarity of the wires that make up each wire pair.

If a twisted pair cable is to join two ports and only one of the ports has an internal crossover, the two pairs must be straight through, as listed in Table 5 on page 13.

Table 5: RJ-45 Pin assignments, straight through cable.

End 1	End 2
1 (TX+)	1 (TX+)
2 (TX-)	2 (TX-)
3 (RX+)	3 (RX+)
6 (RX-)	6 (RX-)

If a twisted pair cable is used to join two ports and either both ports are labelled with an "X" or neither port is labelled with an "X", a crossover must be included in the wiring. Table 6 on page 13 lists the RJ-45 crossover wiring pin assignments.

Table 6: RJ-45 Pin assignments, crossover cable.

End 1	End 2
1 (TX+)	3 (TX+)
2 (TX-)	6 (TX-)
3 (RX+)	1 (RX+)
6 (RX-)	2 (RX-)

Redundant Power Supply

AC models of AT-8700XL Series switches have a Redundant Power Supply (RPS) connector on their rear panel. Table 7 on page 14 lists the connector's pin numbers and pin functions.

Table 7: RPS Connector Pin Numbers and Functions.

Pin Number	Function
1	+12VDC
2	Remote Sense (RS) +5VDC
3	Remote Sense (RS) Ground
4	Remote Sense (RS) +3.3VDC
5	Redundant Power Supply (RPS) Present
6	Ground (+3.3VDC Return)
7	Ground (+5VDC Return)
8	+5VDC
9	Ground (+12VDC Return)
10	+3.3VDC
11	Ground (+3.3VDC Return)
12	+3.3VDC
13	Ground (+3.3VDC Return)
14	+3.3VDC
15	+5VDC
16	Ground (+5VDC Return)

Table 8 on page 14 illustrates the connector's pin layout.

Table 8: RPS Connector's Pin Layout.

16	15	14	13	12	11	10	9
8	7	6	5	4	3	2	1

Pin 16 is at the connector's top left, while pin 1 is at its lower right.

Switch Cables and Loopback Plugs

This section describes how to make cables for connecting the switch's interfaces to networks, terminals, and printers. How to make loopback plugs for testing switch interfaces is also described.

Terminal and Modem Cables

Figure 6 on page 15 shows how to wire cables to connect a standard VT100 compatible terminal, or a modem, to the switch's RS-232 Terminal Port.

Figure 6: Pin wiring diagram for a standard DB9 male to female terminal cable.

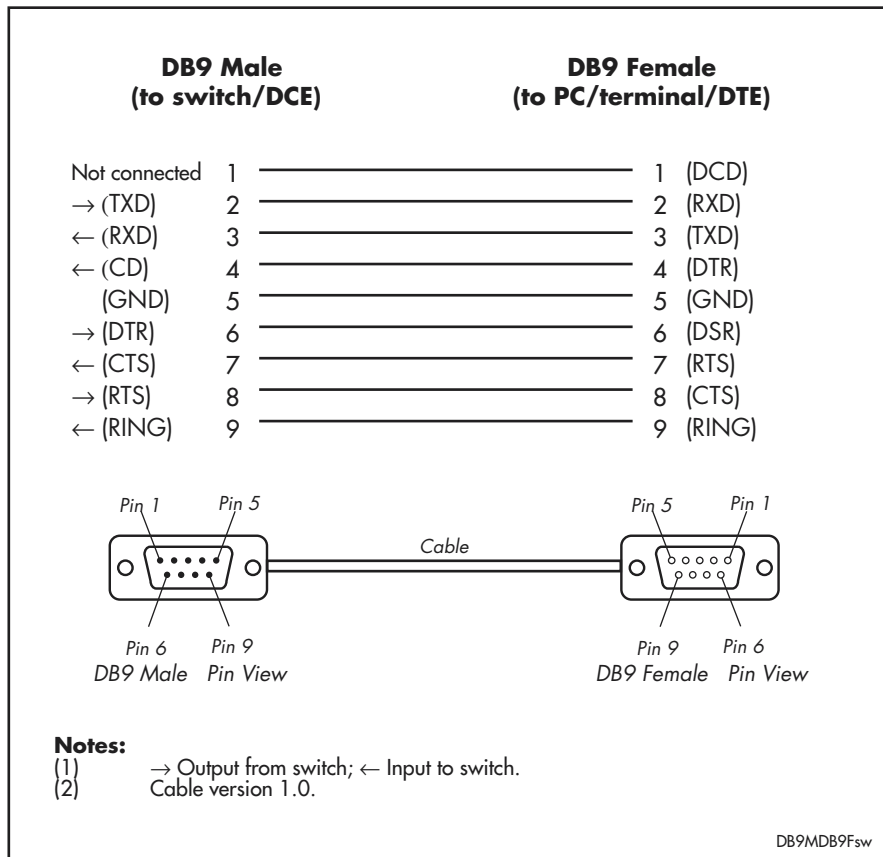
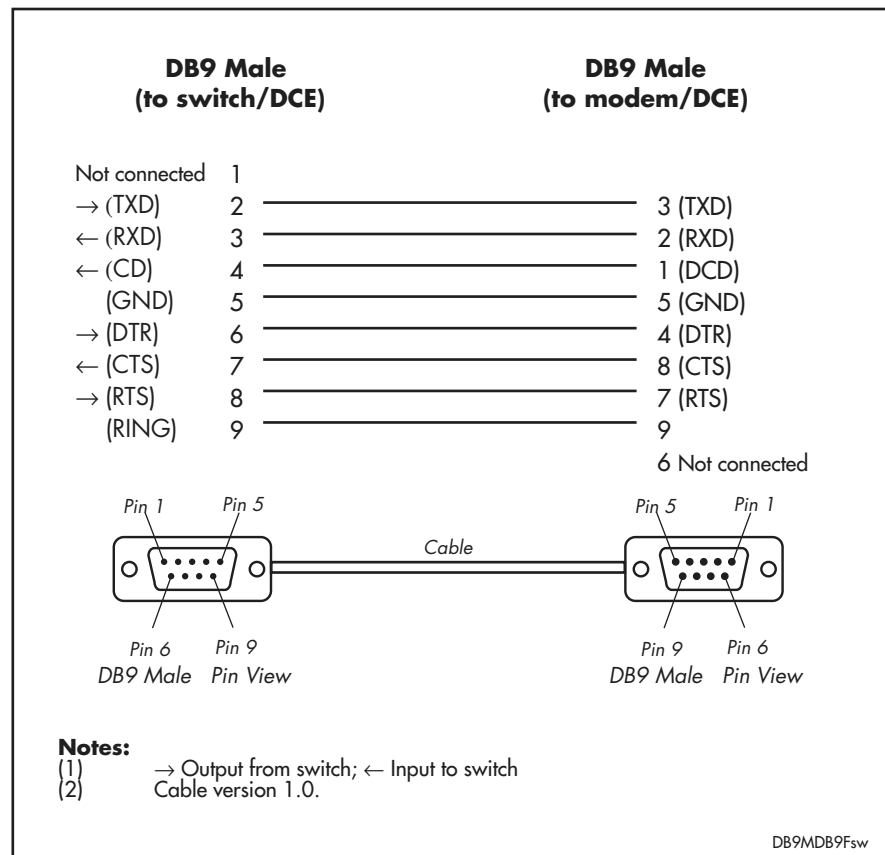

Figure 7: Pin wiring diagram for a DCE RS-232 Terminal Port (DB9 female connector) male to male modem cable.



The switch's RS-232 Terminal Port has a DCE female socket. This allows the use of a straight-through cable when connecting the switch to a terminal or PC. Output from the SHOW ASYN command will, however, still have a DTE perspective. The internal DTE pin roles are listed in Table 9 on page 16.

Table 9: Internal DTE pin roles.

Pin	Role
2	TXD
3	RXD
4	CD
5	GND
6	DTR
7	CTS
8	RTS

Loopback Plugs for Testing Switch Interfaces

Loopback plugs are used in conjunction with the Test Facility software to test the physical interfaces on the switch (see the “Test Facility” section beginning on page 22 of this Reference, and the *Test Facility* chapter of the *AT-8700XL Series Software Reference*). The purpose of a loopback plug is to connect the output pins on the interface to the input pins so that any data transmitted over the interface is looped back and received at the same interface.



Gigabit copper interfaces (as found on the AT-A39/T uplink module) cannot be looped back. Loopback plugs can only be used in conjunction with 10/100 Ethernet interfaces.

On interfaces with control signals, these are also looped back. The data received on the interface is compared with the data transmitted to determine whether or not the interface is functioning correctly. In order to produce a comprehensive test report for the interface being tested, most tests performed by the Test Facility require a loopback plug to be inserted.

Figure 8: Ethernet twisted pair (TP) loopback plug.

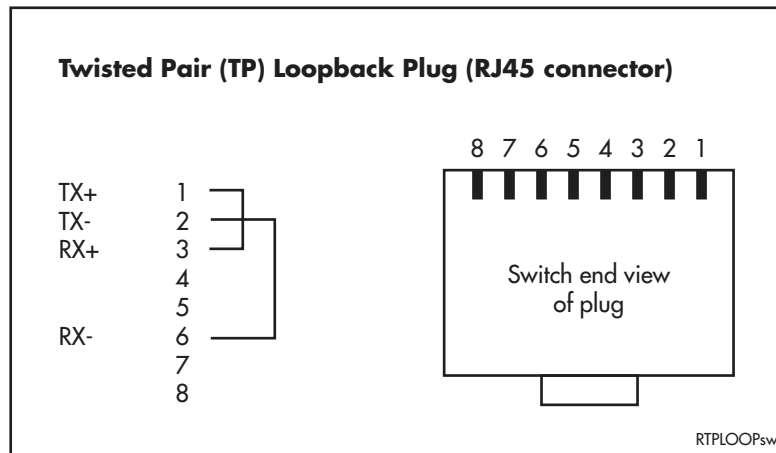

Test Facility

This section introduces the Test Facility. The Test Facility is built into all AT-8700XL Series software. For detailed information on operating the Test Facility, see the Test Facility chapter of the AT-8700XL Series Software Reference.

The Test Facility is designed to test the switch’s physical interfaces. Testing should not be performed while the switch is operational as the presence of a loopback plug may cause feedback of network traffic. Also, any interfaces being tested are dedicated to the Test Facility. The Test Facility can be thought of as a specialised interface module like PPP or Frame Relay.

Test results are displayed with the command:

```
SHOW TEST
```

which produces a display like that shown in Figure 9 on page 18.

Figure 9: Example output from the SHOW TEST command.

Board	ID	Bay	Board Name	Rev	Serial number
Base	108		8724 AT-8724XL	M1-1	6845425
Uplink	88	1	AT-A35SX/SC-00	P1-0	14269019

Interface	State	Result	Type	Duration (minutes)	Details Data(%OK)	Control
port1	no test	-	-	-	-	-
port2	no test	-	-	-	-	-
port3	no test	-	-	-	-	-
port4	no test	-	-	-	-	-
port5	no test	-	-	-	-	-
port6	no test	-	-	-	-	-
port7	no test	-	-	-	-	-
port8	no test	-	-	-	-	-
port9	no test	-	-	-	-	-
port10	no test	-	-	-	-	-
port11	no test	-	-	-	-	-
port12	no test	-	-	-	-	-
port13	no test	-	-	-	-	-
port14	no test	-	-	-	-	-
port15	no test	-	-	-	-	-
port16	no test	-	-	-	-	-
port17	no test	-	-	-	-	-
port18	no test	-	-	-	-	-
port19	no test	-	-	-	-	-
port20	no test	-	-	-	-	-
port21	no test	-	-	-	-	-
port22	no test	-	-	-	-	-
port23	no test	-	-	-	-	-
port24	no test	-	-	-	-	-
port26	no test	-	-	-	-	-
asyn0	no test	-	-	-	-	-

10/100 Ethernet LAN Port Tests

A loopback plug is required to run the first part of the Ethernet LAN test. See “Loopback Plugs for Testing Switch Interfaces” on page 22 for details of how to make a loopback plug. To start an Ethernet interface test, use the command:

```
ENABLE TEST INT=PORTn
```

where *n* is the Ethernet interface number. The test will run for 4 minutes. Use the SHOW TEST command to observe the test progress.

Troubleshooting

This section provides information on how to detect and resolve problems with AT-8700XL Series switches and their expansion options.

Other sources of useful troubleshooting information are:

- www.alliedtelesyn.com.
- *The AT-8700XL Series Software Reference*.

Performing the following tasks will eliminate the most common faults.

1. Make sure the power cord is securely connected.
2. Check that the power supply voltage is stable.
3. Check that the correct data cables are being used and that their connections are secure.
4. Make sure that other network devices are working properly.
5. Use the `SHOW INSTALL` command to check that the latest software release is loaded. See the *AT-8700XL Series Software Reference* for more information about obtaining the latest software release.
6. If the switch is malfunctioning, reboot it by pressing the recessed Reset button or entering the command `RESTART REBOOT`. Alternatively, power OFF and ON the switch by disconnecting and reconnecting the main power supply (including, if connected, the RPS power).

LEDs and What They Mean

The following tables outline how the Switch and Uplink Modules report faults and operational activities. Uplink Modules are expansion options and can be purchased separately. Contact an Authorised Allied Telesyn distributor or reseller, or visit www.alliedtelesyn.com for more information on purchasing expansion options.

Switch LEDs

These LEDs are on the front or rear panels of AT-8700XL Series switches.

Table 10: System LEDs (All AT-8700XL Series switches).

LED	State	Function
Power	Green	The switch is receiving power and the voltage is within the acceptable range
Fault	Red	The switch or management software is malfunctioning
	1 flash	A switch fan has failed. (The LEDs will not indicate an RPS fan failure.)
	3 flashes	If an RPS is connected, the switch's PSU (Power Supply Unit) has failed
	4 flashes	If RPS monitoring is enabled, the RPS PSU has failed
	5 flashes	If RPS monitoring is enabled, an RPS is not connected or is not operational
RPS ¹ (Redundant Power Supply)	Green	An RPS is connected to the switch

1. DC models of the AT-8700XL Series switches do not have an RPS connector and the RPS LED will not function

Table 11: Switch Port LEDs (AT-8724XL and AT-8748XL).

LED	State	Function
L/A (Link/Activity)	Green	A 100 Mbps link is open
	Flashing Green	100 Mbps activity is occurring
	Amber	A 10 Mbps link is open
	Flashing Amber	10 Mbps activity is occurring
D/C (Duplex/Collision)	Green	The port is operating at full-duplex
	Amber	The port is operating at half-duplex
	Flashing Amber	Collisions are occurring on the line

Uplink Module LEDs

The following tables may be helpful when diagnosing possible operational faults. These LEDs are located on the face-plate of the respective Uplink Module model.

Table 12: Uplink Module LEDs (AT-A35-SX/SC and AT-A35-LX/SC).

LED	State	Function
Link	Green	The port is receiving light
	Off	No link is present
Activity	Flashing Amber	Frames are being transmitted or received through the port
	Off	No activity is occurring

Table 13: Uplink Module LEDs (AT-A39-T/RJ-45).

LED	State	Function
Full Dup/Half Dup/Col	Green	The port is operating at full-duplex
	Amber	The port is operating at half-duplex
	Flashing amber	Collisions are occurring
	Off	No link is present
Activity	Green	A 1000 Mbps link is open
	Flashing green	1000 Mbps activity is occurring
	Amber ¹	A 10/100 Mbps link is open
	Flashing Amber ¹	10/100 Mbps activity is occurring
	Off	No link is present

1. Early versions of the AT-A39/T operate at 1000 Mbps only.

Table: 14 AT-A40/SC, AT-A40/MT, AT-A41/SC and AT-A41/MT LEDs.

LED	State	Function
Activity/Link/Fault	Green	A link is open and the port is enabled
	Flashing green	100 Mbps activity is occurring
	Flashing amber (and lower LED is Off)	The link has failed at the remote end
	Off	No link is present
Full Dup/Half Dup/Col	Green	The port is operating at full-duplex
	Amber	The port is operating at half-duplex
	Flashing amber	Collisions are occurring
	Off	No link is present
Both LEDs	Alternate flashing of upper and lower LED, amber	The switch does not support this model of uplink module

Table: 15 AT-A42/GBIC LEDs .

LED	State	Function
L/A Link/Activity	Green	A 1000 Mbps link is open
	Flashing green	1000 Mbps activity is occurring
	Flashing amber (and GBIC LED is Off)	A TX fault has occurred
	Off	No link is present
GBIC	Green	The switch has recognised the GBIC, the GBIC is a valid model
	Green (and L/A LED is flashing GREEN)	The port is operating at full-duplex
	Amber (and L/A LED is OFF)	The switch has not recognised the GBIC, the GBIC is not a valid model
	Amber (and L/A LED is flashing GREEN)	The port is operating at half-duplex
	Flashing amber (and L/A LED is flashing GREEN)	Collisions are occurring
	Off	No GBIC is installed, or a TX fault has occurred
Both LEDs	Slow alternate flashing of L/A and GBIC LED, amber	The switch has not recognised the GBIC, or the GBIC is not a valid model

Some common problems and how to solve them

Link/Activity LED on any port is off

This can indicate:

- A loose data cable.
- The device at the other end of the connection is not working properly or is turned off.
- The data cable is not wired correctly.
- The network administrator has manually disabled the port through the software.
- The port's selected transmission mode does not match that of the attached device.

Perform the following steps in sequence:

1. Make sure the data cable connections are secure.
2. Make sure the device at the other end of the connection is switched on and working properly.
3. Check that the data cable is wired correctly.
4. If you can, log in and check the port status. See "To Log In" on page 12 for more information on how to log in.
5. If the port is Enabled, make sure the transmission speed matches that of the connected device (auto-negotiating, full or half-duplex).



If the port is disabled, someone has used the software to manually disable it. You should find out why the port was disabled before enabling it.

Power LED is off

This can indicate:

- A loose power cord.
- A power supply failure.

Perform the following steps in sequence:

1. Check that the power cord connections are secure.
2. Check that all switches and circuit protection devices are in the ON position.
3. Ensure that the supply voltage is within the operational range (110/240 VAC 50/60 Hz for AC models, 36-59 VDC for DC models).

Fault LED is on

This can indicate:

- There is a problem with the switch or RPS PSU.
- The switch or management software is malfunctioning.
- A hardware fault is preventing switch start-up.

Perform the following steps in sequence:

1. Check Table 10 on page 19 for descriptions and explanations of LED flashing sequences.
2. Reset the switch by pressing the recessed RESET button on the front panel.
3. If you were attempting to download software or manage the switch via the RS-232 terminal Port, check that connections between the Terminal Port and local terminal or PC are secure.

If you cannot access the switch's software because of a faulty RS-232 Terminal Port connection, you can still manage the switch via Telnet or SNMP until the problem is fixed.

4. Unplug the switch and then plug it in again. If present, you will also have to disconnect and reconnect the RPS unit.
5. Download the latest software release. See the *AT-8700XL Series Software Reference* for more information on how to obtain the latest software release.

Expansion Options

This section provides an overview of the expansion options for AT-8700XL Series switches. The following expansion options were available when this Reference was written. See your Authorised Allied Telesyn distributor or reseller, or visit www.alliedtelesyn.com to see if any new options are available.

Uplink Modules

Uplink Modules increase switching capacity by providing a maximum of two extra ports and by allowing switches to be linked together in stacks. For the AT-8700XL Series, Uplink Modules with gigabit capacity are available.

Uplink Modules in the following list are the only modules that should be installed into AT-8700XL Series switches. Check with your Authorised Allied Telesyn distributor or reseller, or visit www.alliedtelesyn.com to see if any new Uplink Module models are available.

Uplink Modules currently available include:

- AT-A35-SX/SC 1-port 1000BASE-SX (SC connector)
- AT-A35-LX/SC 1-port 1000BASE-LX (SC connector)
- AT-A39-T/RJ-45 1-port 1000BASE-T (RJ-45 copper connector)
- AT-A40/SC 1-port 100BASE-FX Multimode Fibre (SC connector)
- AT-A40/MT 1-port 100BASE-FX Multimode Fibre (MT-RJ connector)
- AT-A41/SC 1-port 100BASE-FX Singlemode Fibre (SC connector)
- AT-A41/MT 1-port 100BASE-FX Singlemode Fibre (MT-RJ connector)
- AT-A42/GBIC 1-port 1000BASE-X (GBIC slot)



For more information on Uplink Modules, contact your Authorised Allied Telesyn distributor or reseller, or see the Uplink Module Hardware Reference. This and other documentation can be found on the AT-8700XL Series Documentation and Tools CD-ROM bundled with your switch, or at www.alliedtelesyn.com.

Port, Connector, and Cable Combinations

This section provides cabling guidelines for each switch model.

Table 16: Cable guidelines.

Model	Port Type(s)	Connector Type(s)	Cable Type ¹	Maximum Cable Length
AT-8724XL	10BASE-T/	RJ-45	10BASE-T Category 3 or better	100m (328ft)
AT-8748XL	100BASE-TX		100BASE-TX Category 5 or better	100m (328ft)

1. Refer to the IEEE 802.3 standards for further cable information

Using Windows Terminal and Windows Hyperterminal

You can use a PC running terminal emulation software as the manager console, instead of a terminal. There are many terminal emulation applications available for PCs, but the most readily available are the Terminal and HyperTerminal applications included in Microsoft Windows 95, 98, 2000, and Windows NT 4.0. In standard Windows installations, HyperTerminal is located in the Start > Programs > Accessories menu.

The key to successful use of terminal emulation software with the switch is to configure the software and switch with matching communications parameters. The following procedures describe how to configure Windows Terminal and HyperTerminal for the default RS-232 Terminal Port settings on the switch, but the same principles apply to other terminal emulation programs.

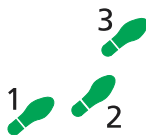

To configure Windows HyperTerminal for Windows 95, 98, 2000, & NT 4.0.

1. In Windows, select:

- Programs > Accessories > HyperTerminal.
- Double-click the Hypertrm.exe icon.

2. In the Connection Description dialog box:

- Enter a name for the connection (e.g., 8724XL)
- Select an icon from the scrolling list.
- Click "OK".

3. In the Phone Number dialog box:

From the "Connect using:" drop-down list, select:

- "Direct to Com n" Where "COM n" is the COM port on the PC used to connect to the switch.
- Click "OK".



4. In the COMn Properties dialog box, set:

- Bits per second: 9600.
- Data bits: 8.
- Parity: None.
- Stop bits: 1.
- Flow control: Hardware.
- Click "OK".

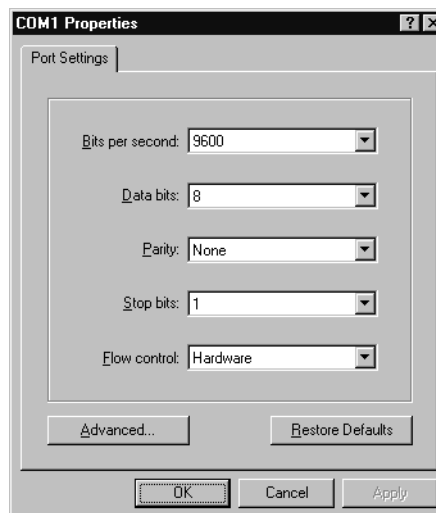

5. From the File menu, select:

- "Properties"

In the Connection Properties dialog box, click the Settings tab and set:

- "Function, arrow, and ctrl keys act as" to "Terminal keys"
- "Emulation" to VT100.

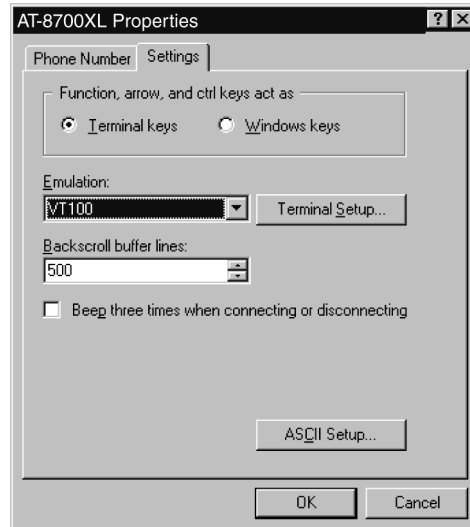

6. Click "ASCII Setup" to display the ASCII Setup dialog box. Uncheck:

- "Echo typed characters locally".
- "Append line feeds to incoming line ends".

Set other parameters as required.

- Click "OK" twice to close all dialog boxes.

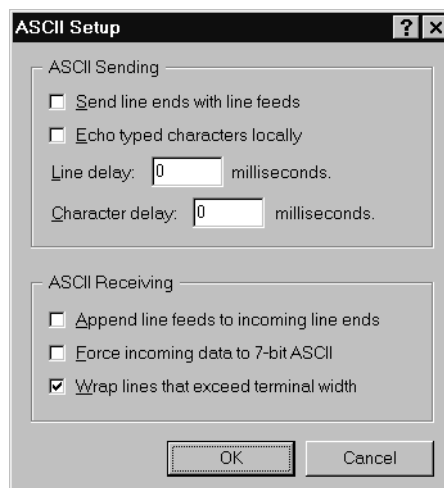

7. Save the current session. From the File menu, select:

- "Save".

This creates a connection icon with the name you assigned in the HyperTerminal group. To use the configuration:

- Double-click the connection icon in the HyperTerminal group.

When the HyperTerminal window appears, press:

- [Enter] a couple of times.

The switch's log in prompt will appear.

Restricted Procedures

This section contains procedures that should only be performed by authorised service personnel. Unauthorised use of procedures in this section may cause danger of injury from electric shock, damage to the switch, and invalidation of the product warranty.

If you would like to know more about the procedures outlined in this section, please contact your authorised Allied Telesyn distributor or reseller.

Diagnostics

The switch software includes a set of diagnostic programs. These programs perform basic level checks of all system components. They do not run in conjunction with the normal operating code, and require that the system be totally dedicated to their use. A detailed knowledge of the way the switch hardware functions is necessary if diagnostics is to be used effectively.



The switch will not perform switching operations if diagnostics are running.



This section is not intended as a guide to the diagnostics software. Diagnostics are designed to be run by service personnel only. For more information, contact your Authorised Allied Telesyn distributor or reseller.

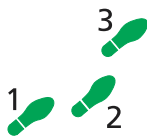

To enable diagnostics mode:

1. Connect a terminal to the RS-232 Terminal Port.

Using an RS-232 DB9 straight-through cable, connect a terminal to the RS-232 Terminal Port on the switch.

Set the terminal communication parameters to the following:

- Baud rate: 9600
- Data bits: 8
- Parity: None
- Stop bits: 1
- Flow control: Hardware

2. Restart the switch.

Restart the switch, either by using a pen or pencil to operate the recessed reset button on the front panel, or by using the terminal to log in and enter the command:

```
RESTART REBOOT
```

See “To Log In” on page 12 for more information on how to log in.

3. Enable diagnostics mode during start-up.

During the switch start-up process, at the prompt:

```
Force EPROM download (Y)?
```

press [Ctrl/D] on the terminal to enter diagnostics mode. A banner page will be displayed on the terminal (Figure 10 on page 28). This can be used to check that the terminal is correctly connected.

Figure 10: AT-8700XL Series diagnostics banner page.

```

* * * Diagnostic Mode * * *

version 25-Jul-02

Main Menu:
0. Restart
1. Full RAM test
2. ROM checksum test
3. Full FLASH test
4. Totally Erase FLASH
5. Battery backed RAM test
Enter selection ==>

```

To run a diagnostic program, enter the corresponding letter or number (or key). There are several sub-menus to cover all the available options. Table 16 on page 24 lists the control keys for diagnostic operations.

Table 17: Basic commands for running the diagnostics .

Key	Function
Q	Quits any running tests and displays the banner page.
S	Prints a summary of test results so far.

A reasonable understanding of the system's structure is needed to operate diagnostics and interpret the results.

To restore the switch to normal operation, use a pen or pencil to operate the recessed reset button on the front panel, or press "0" (zero) to restart.

Replacing Boot EPROMs

AT-8700XL Series switches have two 512 kByte boot EPROMs. The boot EPROMs contain bootstrap code, which loads the main code from a software release file in FLASH memory. In rare circumstances the boot EPROM(s) may need to be changed.



Boot EPROMs should not need to be replaced, except in rare circumstances. Contact your Authorised Allied Telesyn distributor or reseller before replacing any boot EPROMs.

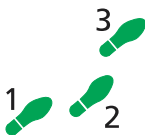

To change the boot EPROMs:

1. Check that you have the correct tools and equipment available.

You will need a medium-sized posidrive screwdriver and an EPROM extraction tool (or a small flat-bladed screwdriver). In addition, adequate antistatic precautions must be used.



E PROMs, like most electronic equipment, are highly sensitive to electrostatic damage. This can be particularly acute in the dry atmosphere normally associated with computer rooms and typical offices. Before commencing work, ensure that you have used an approved antistatic wrist strap to discharge any buildup of static electricity. Wear the strap at all times during the following procedure.

2. Avoid injury by working in a safe environment.

The workspace should be free of hazards, and there should be sufficient room to lay out the switch, the EPROM, and the tools.

3. Disconnect the mains power cord.

4. If fitted, disconnect the redundant power supply.



Do not take risks with mains or backup electricity. Do not attempt to remove the lid of the switch unless all power cords have been disconnected from the switch.

5. Remove the switch's lid.

Using a posidrive screwdriver, remove the 12 screws that secure the switch's lid. There are 5 screws located in countersunk holes on each side of the lid, and 2 screws at the rear. The switch may need to be removed from any rack mounting system before its lid can be removed.

6. Remove the existing boot EPROMs.

The boot EPROM(s) should now be visible.

Figure 11 on page 29 shows the location of boot EPROMs on the CPU board.

Remove the boot EPROMs using the extraction tool. Alternatively, a small flat-bladed screwdriver can be used. If using a screwdriver, gently lever each end of a particular boot EPROM a few millimetres at a time until it comes free.

Figure 11: EPROM locations.

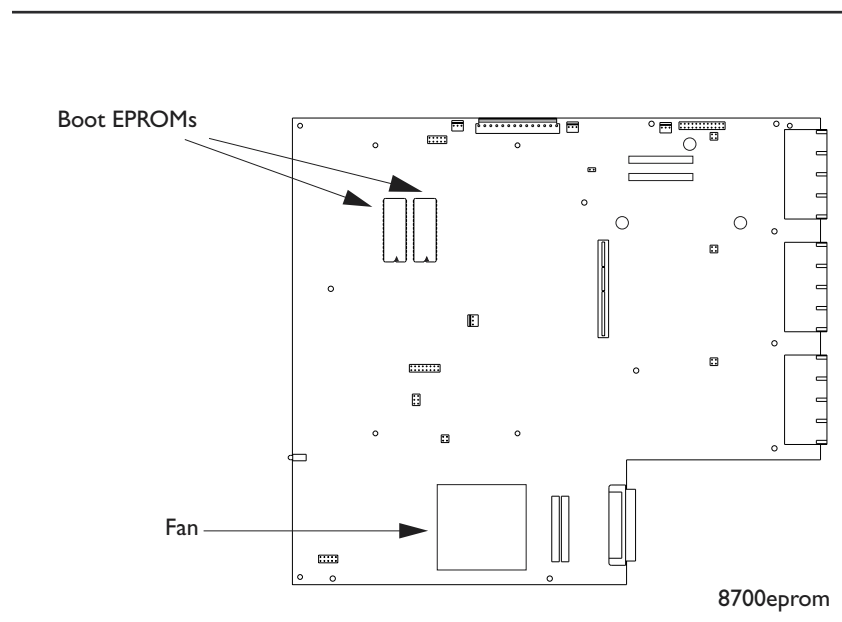

7. Insert the new boot EPROMs.

Insert the new boot EPROMs one at a time, using as a reference the location number printed on the CPU board (e.g., “0” and “1”) and Figure 11 on page 29. Check that the boot EPROMs are firmly seated.



Install the boot EPROMs the correct way up! Failure to do so will almost certainly destroy them. The ‘top’ end of the EPROM has a notch. This should be positioned so that the notched end of the EPROM is orientated as shown in Figur e11 on page29.

8. Replace the switch’s lid and power cord.

Replace the lid and secure it with the 12 posidrive screws. Connect the power cord and (if disconnected in step 4) the RPS.

9. Check that the switch is operating correctly.

Check that the switch boots up correctly. Connect the switch’s RS-232 Terminal Port to a terminal (see page 20 for information on connection cables) and check the start-up messages. See “Switch Start-up” on page 12 for a list of start-up messages. Verify that the new software version is installed by typing the command:

```
SHOW INSTALL
```

which will produce a display like that shown in Figure 12 on page 30. The boot EPROM software release number is shown in the “Default” field. Check that it is correct.

Figure 12: Example output from the SHOW INSTALL command.

Install	Release	Patch
Temporary	-	-
Preferred	flash:load\86s-210.rez	-
Default	EPROM (86s-2.1.0)	-

Current install		

Preferred	flash:load\86s-210.rez	-

Install history		

No Temporary install selected		
Preferred install selected		
Preferred release successfully installed		

Troubleshooting EPROM Installation

If the switch fails to reboot or functions incorrectly, then the most likely cause is that there is a problem with the way the boot EPROMs were installed. Repeat the installation procedure, checking:

- That the boot EPROMs are in the correct locations and oriented correctly (using the relevant location diagram as a guide).
- For bent pins. These should be carefully straightened.

If the switch still fails to reboot, replace the new boot EPROMs with the original set and contact your Authorised Allied Telesyn distributor or reseller.

Contacting Us

With locations covering all of the established markets in North America, Latin America and Europe, Allied Telesyn provides localized sales and technical support worldwide. To find our representative nearest you, visit Allied Telesyn on the web at: <http://www.alliedtelesyn.com>.